



United Pacific

OEM Style Lighting



HOW TO ORDER

To order from United Pacific Industries, you must be an authorized dealer, distributor or OEM.

If you are not authorized to stock and sell United Pacific products, you must order through an authorized dealer.

Please call 800.790.6988 for more information.

CONTACT US

 8 am - 4:30 pm PST

 Sales@upauto.com

 800.790.6988 / 562.421.3888

 UPauto.com

 888.986.5988

 3788 E. Conant St., Long Beach, CA 90808

QUALITY

With over 30 years of experience in the automotive aftermarket industry, United Pacific Industries understands the rigors and stresses that our products are subjected to on the road. It is our mission to provide our customers with products of superior quality and reliability. In achieving this goal, United Pacific only partners with manufacturing facilities that conforms to our quality control requirements and standards. Our manufacturing partners meet or exceed ISO-9001 requirements. In addition, United Pacific's manufacturing partners must be equipped on site to perform the following quality assurance tests and maintain a track record of consistent quality and low product failure rate.

- Photometric Test
- Rain Test
- Shock Test
- Humidity Test
- Pull Force Test
- Salt Spray Test
- Temperature Test
- Vibration Test

Furthermore, our internal quality control structure allows us to function as the final quality control station prior to shipping. With the assistance of 3D computer technology, United Pacific can adhere to strict quality control standards during prototype creation and the production process. Our engineers and technicians perform a battery of tests to ensure that our products meet the demands of today's drivers and our goal to be first in quality.

INNOVATION

Known as the leader in innovation, United Pacific is dedicated to be the first to bring new and exciting products to the market. United Pacific's global expertise allows us to search the globe for new ideas and concepts. Not only do we search the globe for new products, United Pacific invest a significant amount of resources into our own research and development efforts. With the assistance of advance 3D scanning technology, our engineers and designers can acquire accurate and precise data in seconds. The 3D data allows United Pacific to verify designs, perform quality assurance tests, and reverse engineer with unprecedented speed and accuracy. Digital inspection contributes to the early detection of shape problems, provides rapid feedback on design, and eliminates unnecessary work in downstream processes. Our rapid prototyping facility permits us to have a concept-to-shelf time of less than 5 months. In addition, United Pacific's 3D printing capabilities permit our designers to have physical models of their design concepts in hours. The physical models allow our designers and marketing staff to evaluate and test the viability of different design ideas. Our rapid prototyping facility allow United Pacific to compress design cycles, improve manufacturing planning, shorten concept-to-shelf time, most importantly, generate new and innovative products.

DESIGN

Located near some of the nation's most progressive automotive design centers, United Pacific established the UP Design Studio in 2002 to consolidate our position as the design leader in the automotive industry. UP Design Studio utilizes the latest generation of computer aided design (CAD) and studio/graphic software. The design studio is equipped with the newest computers and rapid prototyping systems. In addition, UP Design Studio is staffed by graduates from the nation's most prestigious design colleges. Unlike our competitors, United Pacific's design and manufacturing capabilities mean that we carry more new and original items than our competitors. The establishment of the design studio will enable us to generate even more new products with significant shorter concept-to-shelf time. The reduction in development cost mean that we can develop products utilizing design based development processes. Design based product development allows United Pacific to create new product concepts based on designs incorporating driver demands and needs instead of economic considerations. United Pacific's emphasis on design distinguishes and positions us ahead of our competitors.



WARRANTY

With LED (Light Emitting Diodes) rated at 100,000 hours of operation and solid-state construction, United Pacific's LED lights are extremely reliable and durable. Purchase with confidence, United Pacific offers a complete line of LED lighting products with extended or limited lifetime warranties. Please see the warranty policy page for more details.

INVENTORY AND SHIPPING

United Pacific carries over 20,000 items in our California distribution center. No other company in the heavy duty trucking industry can match United Pacific in the variety and range of in-stock inventories. With an order fill rate of over 98.5%, United Pacific is the largest and most reliable supplier in the industry. Our shipping department ships 96.8% of all orders within 24 hours and 98.9% within 48 hours. United Pacific's vast inventory and prompt shipping has made United Pacific the only source for our customer's chrome and lighting needs.



HARD AT WORK FOR THE ENVIRONMENT



United Pacific
132,000 sq ft

Distribution Center
Long Beach, CA

100%

reduction in potable water used for landscaping

40%

reduction in total energy use due to high-efficiency mechanical and lighting systems

82%

of construction waste was diverted from landfills

LEED ACCOMPLISHMENTS

Sustainable Sites

- On-site bicycle storage, showers and changing areas for company employees.
- Preferred parking for low-emitting, fuel-efficient and carpool vehicles.
- Storm water is infiltrated on-site and treated to remove contaminants to reduce environmental impact on local waterways.

Water Efficiency

- In addition to using reclaimed water, drought-tolerant plants and a high-efficiency irrigation system were installed to reduce the use of potable water for irrigation by 100%.

Energy and Atmosphere

- Efficient HVAC equipment and a lighting system with daylight controls reduces energy consumption by over 30%.
- Enhanced commission verifies that the building's energy and water-related systems are performing as intended by the initial design.

Indoor Environmental Quality

- Building ventilation systems was designed to provide enhanced levels of fresh outside air to building occupants.
- Interior finishes (plants, sealants, adhesives, coatings, carpet systems and composite wood) were selected with low levels of volatile organic compounds (VOCs) to reduce indoor air contamination.



TABLE OF CONTENTS

LED Clearance/Marker Lights	07
LED S/T/T, P/T/C Lights	25
LED Back-Up, License, & Auxiliary Lights	45
LED Warning Lights	50
LED Light Bars	55
LED Work Lights	59
Incandescent Clearance Marker Lights	69
Incandescent S/T/T, P/T/C Lights	73
Incandescent Back-Up & License Lights	76
Reflectors	80
Mounting Accessories	81
Electrical Accessories	86
Federal Regulations	96
Terms & Conditions/Ordering	102
Shipping Policy/Claims	103
Warranty Policy>Returns	104
Returns/Catalogs/Disclaimer	105
Index	106



Reliable. Hardworking. Quality products.
UPauto.com

Your customers can express their individual style with United Pacific's long-lasting OEM lighting. They're built to adhere to the manufacturer's original specs, are easy-install, and will instantly increase safety and visibility. These striking LED lights can be found on our sturdy Light Bars, as well as Turn Signal, Back-Up, Clearance/Marker, and Stop, Turn & Tail lights, ensuring trucks are seen better and brighter at every angle.



Red, clear, or amber lenses cast a dynamic infinity vision effect boldly visible to all passing drivers, and are just as eye-catching while the truck's in park.



View products on pages 15, 32, 45, & 46.



The patented GloLight line emits a warm, vivid glow effect while running, and all LED-lit on stop. Featured on over 50 products in a variety of sizes, shapes, and colors.



View products on pages 10, 11, 17, 24, 25, 28, 30, 31, 33, 34, 37, 40, 43, 45, 46.

Mirage

With a limitless mirror effect and fiery iris glow, the Mirage line is for drivers looking for a distinctive presence on both interstates and local roads.



View products on pages 16, 26, & 33.

Turbine Light

A beam of crisp, circular LEDs, featuring a signature windmill design on the outer rim, powers through even the most inclement weather.

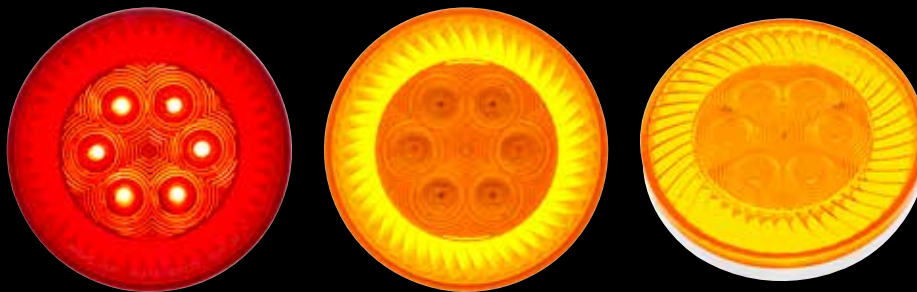

View products on pages 14, 25, & 32.

Viper eye

Drivers who want to add a ferocious look to their rig will love this bold snake eye effect gleaming down the road.



View products on page 7.

CLEARANCE MARKER LIGHTS



3 LED 4-3/16" Wide ViperEye Light (Clearance/Marker)

DESCRIPTION

- High quality chrome finish for durability and shine
- Polycarbonate lens sonically sealed to housing to prevent moisture intrusion
- 3 bright SMD type LEDs with chrome inner reflective housing
- Unique snake Viper eye effect when powered on
- Beautiful chrome plated snap-on front cover
- Surface mount, 3-1/8" center to center spacing between 2 mounting holes

Item #	LEDs	Lens	Pack	Card
39254	3 Amber	Amber	1 Pc.	Card
39256	3 Red	Red	1 Pc.	Card

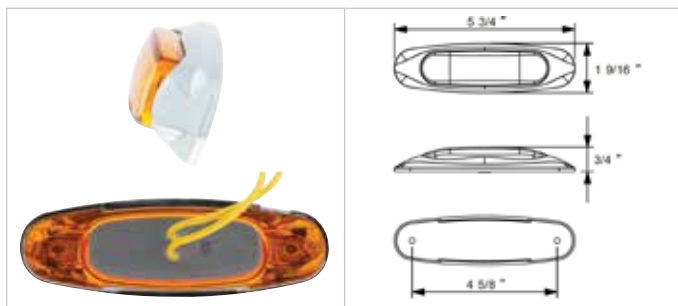

3 LED 5-3/4" Wide ViperEye Light (Clearance/Marker)

DESCRIPTION

- High quality chrome finish for durability and shine
- Polycarbonate lens sonically sealed to housing to prevent moisture intrusion
- 3 bright SMD type LEDs with chrome inner reflective housing
- Unique snake Viper eye effect when powered on
- Beautiful chrome plated snap-on front cover
- Surface mount, 4-5/8" center to center spacing between 2 mounting holes
- 12VDC, hardwired with 2 wire leads, special electrical design, either wire can be positive or negative
- DOT/SAE, P2
- IP67 water resistant

Item #	LEDs	Lens	Pack	Card
35995	4 Amber	Amber	1 Pc.	Card
35996	4 Red	Red	1 Pc.	Card
35997	4 Amber	Clear	1 Pc.	Card
35998	4 Red	Clear	1 Pc.	Card

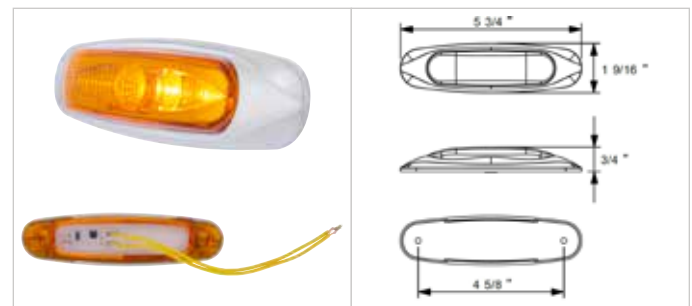

4 LED LIGHTTRACK Light (Clearance/Marker)

DESCRIPTION

- LIGHTTRACK design makes bright guide light and glow effect
- High quality chrome bezel for durability and shine
- 12V DC 2-wire hookup using 0.180" bullet plugs
- Surface mount, 4-5/8" between 2 screw holes
- Recommended plug: item#34203, 34250
- IP67 water resistant

Item #	LEDs	Lens	Pack	Card
36815	4 Amber	Amber	1 Pc.	Card
36816	4 Red	Red	1 Pc.	Card
36817	4 Amber	Clear	1 Pc.	Card
36818	4 Red	Clear	1 Pc.	Card



4 LED Rectangular Clearance/Marker Light - Reflector

DESCRIPTION

- 4 LED reflector clearance/marker light w/chrome plastic bezel
- Polycarbonate lens sonically sealed to housing to prevent moisture intrusion
- Recommended plug: item # 34203/34250

Item #	LEDs	Lens	Pack	Bulk
39398B	4 Amber	Amber	1 Pc.	Bulk
39399B	4 Red	Red	1 Pc.	Bulk



GloLight™

16 LED Rectangular GloLight With Bezel

DESCRIPTION

- Polycarbonate lens sonically sealed to housing to prevent moisture intrusion.
- Fully epoxy sealed electronics to resist corrosion and moisture.
- Unique patented GloLight design, US D733946.
- Hard wired with 2 wires, works with any 12V DC system.
- Surface mount, 3-7/8" center to center mounting hole spacing.
- Wiring color code: White=Ground, Black=Positive.
- DOT/SAE, FMVSS 108.
- IP67 water resistant.

Item #	LEDs	Lens	Pack	Card
36980	16 Amber	Amber	1 Pc.	Card
36980B	16 Amber	Amber	1 Pc.	Bulk
36981	16 Red	Red	1 Pc.	Card
36981B	16 Red	Red	1 Pc.	Bulk



CLEARANCE MARKER LIGHTS

6 LED Light (Clearance/Marker) W/ 6 LED Side Ditch Light Chrome Bezel

DESCRIPTION

- Quality clear polycarbonate lens with beautiful chrome inner housing
- Feature 6 bright amber SMD LEDs and 6 additional SMD LEDs as side ditch light
- Lens and back housing sonically sealed to prevent moisture intrusion
- Easy wiring, 3 hardwired leads with .180" male bullet plugs
- Works with any 12V DC system
- Surface mount, 3-15/16" center-to-center mounting hole spacing
- DOT/SAE, P2 and IP67 water resistant
- Wiring color code: Black=Clearance/Marker light, Red=Ditch Light, White=Ground
- Recommended plug: item#34191, 34192
- Note: due to lens design, ditch light may show on side lens when clearance/marker is off

Item #	LEDs	Ditch Light	Pack	Card
39298	6 Amber	6 White	1 Pc.	Card
39299	6 Amber	6 Amber	1 Pc.	Card
39300	6 Amber	6 Blue	1 Pc.	Card
39301	6 Amber	6 Red	1 Pc.	Card
39302	6 Red	6 White	1 Pc.	Card
39303	6 Red	6 Amber	1 Pc.	Card
39304	6 Red	6 Blue	1 Pc.	Card
39305	6 Red	6 Red	1 Pc.	Card

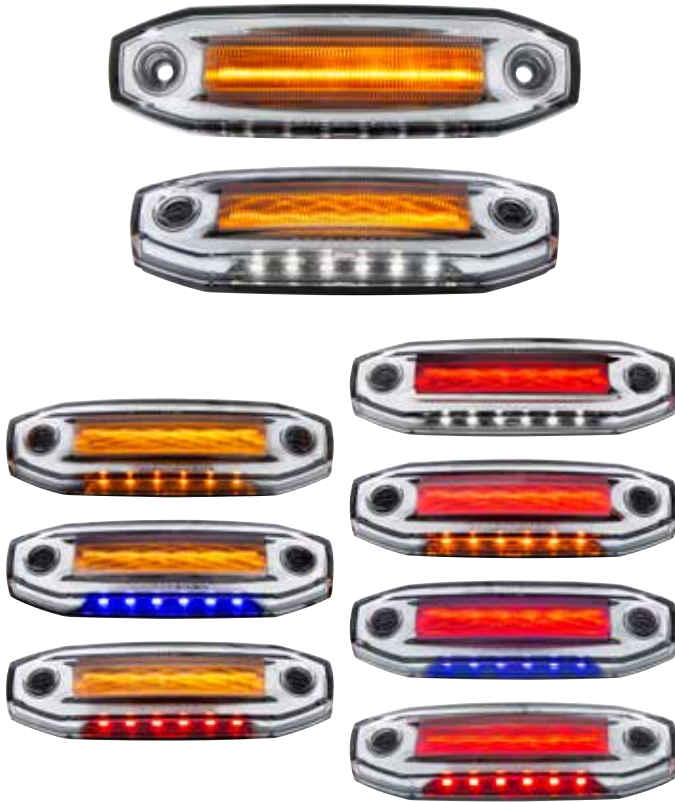

5 LED Reflector Light (Clearance/Marker) With Side Ditch Light

DESCRIPTION

- Down facing white LED ditch lights create better visibility and safety at night
- Features 3 bright primary LEDs, and 2 downward facing white LEDs
- High quality chrome bezel for durability and shine
- SAE/DOT P2 and IP67 water resistant
- Surface mount, 3-1/8" center to center spacing between 2 mounting holes
- 12 volt, 2-wire hookup
- Wiring color code: Black=Positive, White=Ground
- Ship in bulk

Item #	LEDs	Ditch Light	Lens	Pack
39311	5 Amber	Amber	Clear	Card
39311B	5 Amber	Amber	Clear	Bulk
39312	5 Amber	Red	Clear	Card
39312B	5 Amber	Red	Clear	Bulk
39313B	5 Amber	White	Clear	Bulk





6 LED M5 Millennium GloLight (Clearance/Marker)

DESCRIPTION

- 6 LED M5 "Millennium" clearance/marker light with chrome plastic bezel
- Beautiful high quality chrome plated injection molded plastic
- Polycarbonate lens sonically sealed to housing to prevent moisture intrusion
- Hard wired with 2 wires, works with any 12V DC system
- Unique patented GloLight design, US D738548

Item #	LEDs	Lens	Pack	Card
36984	6 Amber	Amber	1 Pc.	Card
36984B	6 Amber	Amber	1 Pc.	20/Cartron
36985	6 Red	Red	1 Pc.	Card
36985B	6 Red	Red	1 Pc.	20/Cartron
36986	6 Amber	Clear	1 Pc.	Card

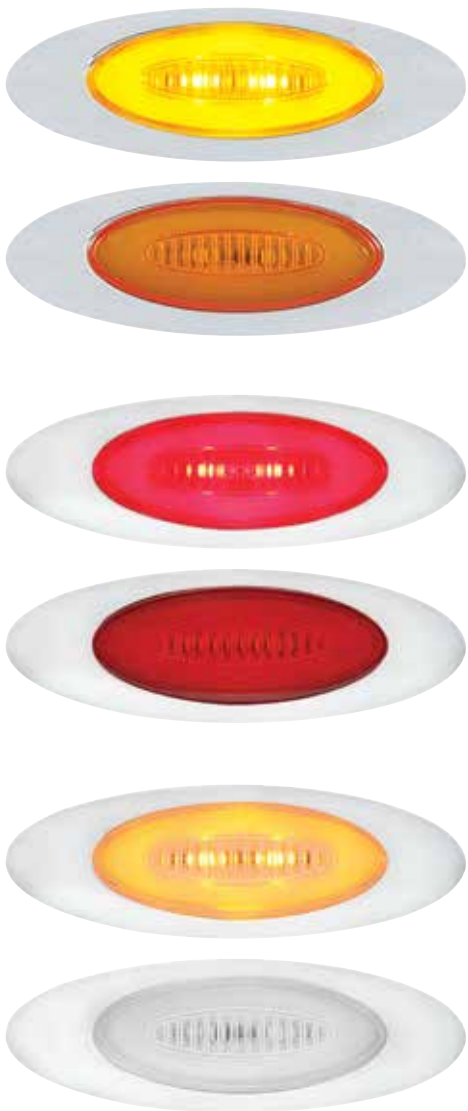

13 LED M1 Millennium GloLight (Clearance/Marker)

DESCRIPTION

- Polycarbonate lens sonically sealed to housing to prevent moisture intrusion
- High quality chrome bezel for durability and shine
- Hard wired with 2 wires, works with any 12V DC system
- Unique patented GLO design, US 9,062,845B1
- Surface mount, 4-5/8" center-to-center spacing between 2 mounting holes
- DOT/SAE, FMVSS 108
- IP67 water resistant

Item #	LEDs	Lens	Pack	Card
36988	13 Amber	Amber	1 Pc.	Card
36988B	13 Amber	Amber	1 Pc.	20/Cartron
36989	13 Red	Red	1 Pc.	Card
36989B	13 Red	Red	1 Pc.	20/Cartron
36990	13 Amber	Clear	1 Pc.	Card

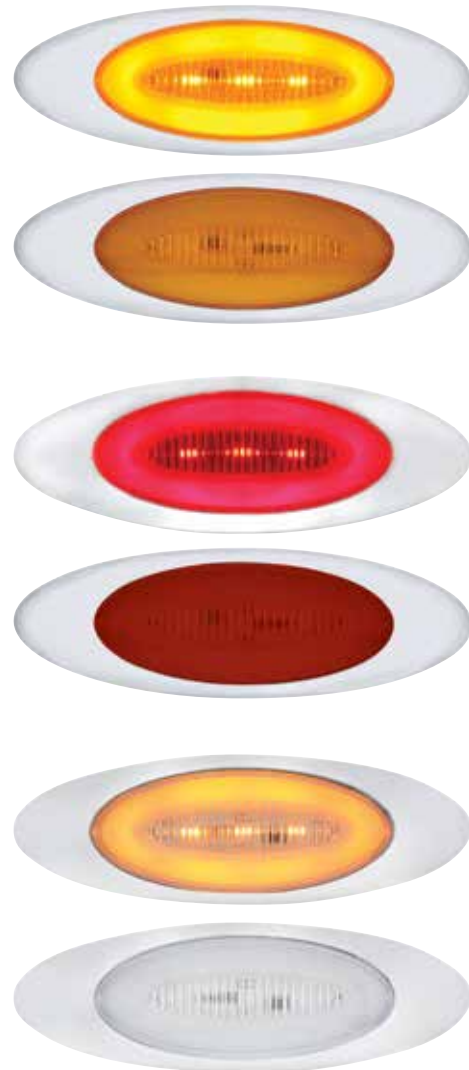

CLEARANCE MARKER LIGHTS



5 LED M3 Millennium GloLight (Clearance/Marker)

DESCRIPTION

- 5 LED M3 Millennium series clearance/marker light with chrome plastic bezel
- Polycarbonate lens sonically sealed to housing to prevent moisture intrusion
- Unique patented GLO design. Hard wired with 2 wires

Item #	LEDs	Lens	Pack	Card
36968	5 Amber	Amber	1 Pc.	Card
36969	5 Red	Red	1 Pc.	Card
36970	5 Amber	Clear	1 Pc.	Card
36971	5 Red	Clear	1 Pc.	Card

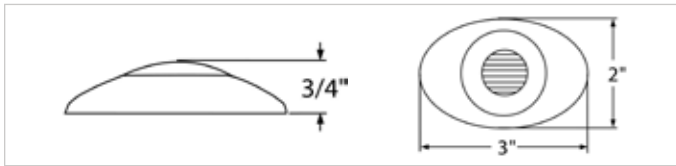

6 LED 1-1/4" Dual Function Light (Clearance/Marker)

DESCRIPTION

- High quality injection molded polycarbonate lens
- Epoxy coated, fully sealed electronics designed for 12V DC systems
- Feature 6 bright SMD type dual function LEDs
- Includes polished stainless steel bezel and quality rubber grommet
- Easy wiring, 7" of 18G wires with 0.180" male bullet plugs
- Maximum mounting hole diameter 1-7/16", minimum 1-3/8"
- DOT/SAE, P2

Item #	LEDs	Lens	Pack	Card
36035	6 Amber	Amber	1 Pc.	Card
36036	6 Red	Red	1 Pc.	Card
36037	6 Amber	Clear	1 Pc.	Card

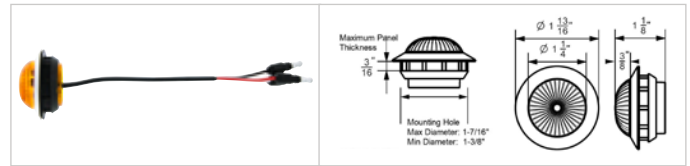

3 LED Dual Function Mini Light (Clearance/Marker) With Faceted Crystal

DESCRIPTION

- Bright LEDs behind beautiful, faceted crystal design lens.
- Polycarbonate lens body with epoxy sealed 12VDC electronics.
- Polished stainless steel bezel, UP #20527B.
- Mounts with included rubber grommet.
- Hard wired with 3 wires.
- Requires 3/4" diameter hole for installation.

Item #	LEDs	Lens	Pack	Card
36869	3 Amber	Amber	1 Pc.	Card
36870	3 Blue	Blue	1 Pc.	Card



3 High Power LED 1" Light (Clearance/Marker) With Visor

DESCRIPTION

- 3 high power LED 1" clearance/marker light with visor
- Polycarbonate lens sonically sealed to housing to prevent moisture intrusion
- Bright amber LEDs with quality clear lens
- M12x1.25mm threaded stud with matching nut

Item #	LEDs	Lens	Pack	Card
36905	3 Amber	Clear	1 Pc.	Card
36906	3 Blue	Clear	1 Pc.	Card
36907	3 Red	Clear	1 Pc.	Card
36908	3 White	Clear	1 Pc.	Card



3 High Power LED 1" Light (Clearance/Marker) With Visor

DESCRIPTION

- 3 high power LED 1" clearance/marker light with visor
- Polycarbonate lens sonically sealed to housing to prevent moisture intrusion
- Bright amber LEDs with quality amber lens

Item #	LEDs	Lens	Pack	Card
36897	3 Amber	Amber	1 Pc.	Card
36898	3 Red	Red	1 Pc.	Card



2 LED Mini Light With Bezel (Clearance/Marker)

DESCRIPTION

- 2 LED mini clearance marker light with stainless steel bezel
- Polycarbonate lens sonically sealed to housing to prevent moisture intrusion
- Requires a 3/4" opening, mounts w/ enclosed rubber grommet
- Special lens design, project light 180 degree
- Easy wiring with 8-1/2" long wire leads

Item #	LEDs	Lens	Pack	Pack
37142	2 Amber	Amber	1 Pc.	Card
37143	2 Red	Red	1 Pc.	Card
37144	2 Amber	Clear	1 Pc.	Card



CLEARANCE MARKER LIGHTS

1 LED Mini Clearance Light With Rubber Grommet

DESCRIPTION

- Polycarbonate lens sonically sealed to housing to prevent moisture intrusion
- Feature single SMD LED behind non-directional lens and quality rubber grommet
- Requires 3/4" diameter hole for installation
- DOT/SAE, P2 certified
- Lifetime warranty

Item #	LEDs	Lens	Pack	Pack
36743B	1 Amber	Amber	1 Pc.	Bulk
36744B	1 Red	Red	1 Pc.	Bulk
36745B	1 Amber	Clear	1 Pc.	Bulk



2 LED Mini Light (Clearance/Marker) With Rubber Grommet

DESCRIPTION

- 2 LED mini clearance/marker light
- Polycarbonate lens sonically sealed to housing to prevent moisture intrusion
- Requires 3/4" diameter hole for installation
- Mounts with enclosed rubber grommet
- Hard wired with 3 wires

Item #	LEDs	Lens	Pack	Bulk
36849B	2 Amber	Amber	1 Pc.	Bulk
36850B	2 Red	Red	1 Pc.	Bulk



3 LED Mini Clearance/Marker Light

DESCRIPTION

- 3 LED mini clearance/marker light
- Polycarbonate lens sonically sealed to housing to prevent moisture intrusion
- Requires a 3/4" opening, mounts w/ enclosed rubber grommet

Item #	LEDs	Lens	Pack	Bulk
39767B	3 Amber	Amber	1 Pc.	Bulk
39768B	3 Red	Red	1 Pc.	Bulk



Turbine Light

7 LED 2" Round Turbine Light (Clearance/Marker)

DESCRIPTION

- Polycarbonate lens sonically sealed to housing to prevent moisture intrusion
- Electronics completely sealed in epoxy to resist corrosion and moisture
- Energy efficient solid-state circuit board engineered for 12V DC systems
- Features 7 bright SMD type LEDs
- Unique turbine fin design on outer rim
- Rear housing with 2-pin female contact terminal.
- Recommend mount with rubber push-in grommet, item #31505, 31507 (not included)
- DOT/SAE, FMVSS 108
- IP67 water resistant

Item #	LEDs	Lens	Pack	Card
39222	7 Amber	Amber	1 Pc.	Card
39223	7 Red	Red	1 Pc.	Card



Turbine Light

16 LED 4" Round Turbine Light S/T/T & P/T/C

DESCRIPTION

- Polycarbonate lens sonically sealed to housing to prevent moisture intrusion
- Electronics completely sealed in epoxy to resist corrosion and moisture
- Energy efficient solid-state circuit board engineered for 12V DC systems
- Feature 16 bright SMD type LEDs
- Unique turbine fin design on outer rim, comes on with low function
- High function both outer and inner LEDs turns on
- Rear housing with 3-pin female contact terminal
- Recommend use with 3-pin male plug, item #34212, 34216 (not included)
- Recommend mount with rubber push-in grommet, item #31515 (not included)
- DOT/SAE, FMVSS 108, IP67 water resistant rating
- Amperage draw on high function: 3.2mA, low function: 1.3mA

Item #	LEDs	Lens	Function	Pack
39214	16 Red	Red	S/T/T	Card
39215	16 Amber	Amber	Turn Signal	Card

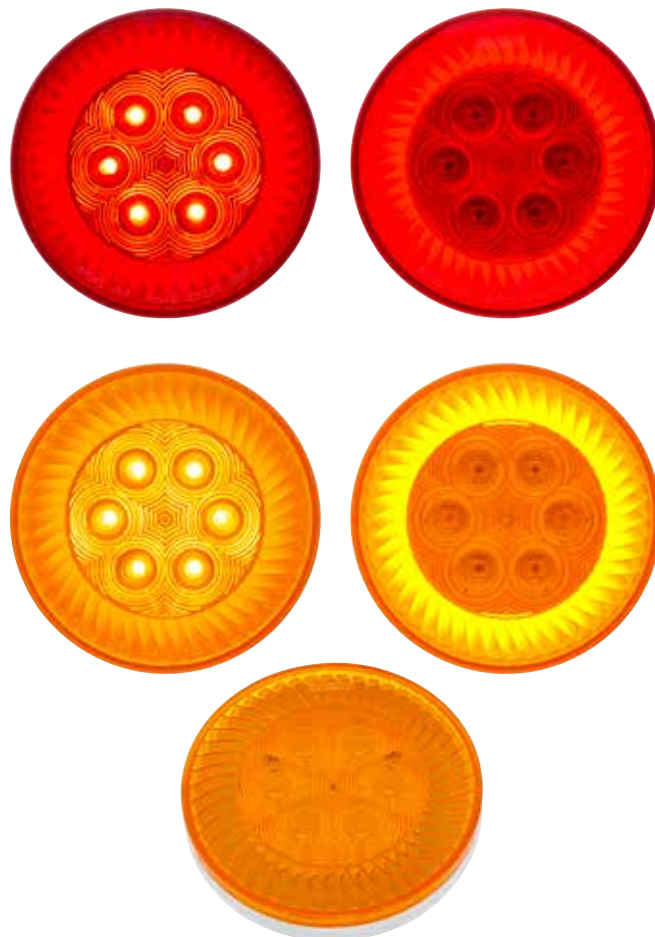

CLEARANCE MARKER LIGHTS



4 LED 2" Round Abyss Light (Clearance/Marker)

DESCRIPTION

- Features 4 bright LEDs with Abyss lens design gives unique infinity vision effect
- Polycarbonate lens sonically sealed to housing to prevent moisture intrusion
- Durable plastic housing with 2 contact female plug, works on all 12V DC systems
- Recommend use with 2-pin male plug, item #34210, 34215 (not included)
- Mounts with standard 2" round rubber push-in grommet, item #31505 (note included)
- DOT/SAE P2, FMVSS 108
- IP67 water resistant

Item #	LEDs	Lens	Pack	Card
36574	4 Amber	Amber	1 Pc.	Card
36575	4 Red	Red	1 Pc.	Card
36576	4 Amber	Clear	1 Pc.	Card
36577	4 Red	Clear	1 Pc.	Card
36578	4 White	Clear	1 Pc.	Card



4 LED 2-1/2" Round Abyss Light (Clearance/Marker)

DESCRIPTION

- Features 4 bright LEDs with Abyss lens design gives unique infinity vision effect
- Polycarbonate lens sonically sealed to housing to prevent moisture intrusion
- Durable plastic housing with 2 contact female plug, works on all 12V DC systems
- Recommend use with 2-pin male plug, item #34210, 34215 (not included)
- Mounts with standard 2" round rubber push-in grommet, item #31505 (note included)
- DOT/SAE P2, FMVSS 108
- IP67 water resistant

Item #	LEDs	Lens	Pack	Card
36579	4 Amber	Amber	1 Pc.	Card
36580	4 Red	Red	1 Pc.	Card
36581	4 Amber	Clear	1 Pc.	Card
36582	4 Red	Clear	1 Pc.	Card
36583	4 White	Clear	1 Pc.	Card





9 LED 2" Round Mirage Light (Clearance/Marker)

DESCRIPTION

- Mirage lens design gives unique limitless mirror effect
- Polycarbonate lens sonically sealed to housing to prevent moisture intrusion
- Durable plastic housing with 2 contact female plug
- Works with any 12V DC system
- Uses 2-pin electrical connector plug, item #34210
- Mounts with standard 2" round rubber push-in grommet, item #31505/31507
- DOT/SAE, FMVSS 108, **Lifetime warranty**

Item #	LEDs	Lens	Pack	Card
36524	9 Amber	Amber	1 Pc.	Card
36525	9 Amber	Amber	1 Pc.	Card
36526	9 Amber	Amber	1 Pc.	Card
36527	9 Amber	Amber	1 Pc.	Card

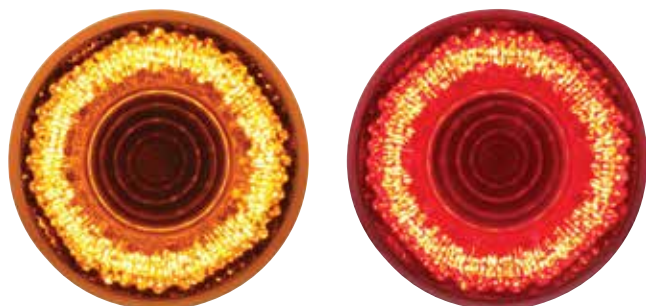

12 LED 2-1/2" Round Mirage Light (Clearance/Marker)

DESCRIPTION

- Mirage lens design gives unique limitless mirror effect
- Polycarbonate lens sonically sealed to housing to prevent moisture intrusion
- Durable plastic housing with 2 contact female plug
- Works with any 12V DC system
- Uses 2-pin electrical connector plug, item #34210
- Mounts with standard 2" round rubber push-in grommet, item #31505/31507
- DOT/SAE, FMVSS 108, **Lifetime warranty**

Item #	LEDs	Lens	Pack	Card
36560	12 Amber	Amber	1 Pc.	Card
36561	12 Red	Red	1 Pc.	Card
36562	12 Amber	Clear	1 Pc.	Card
36563	12 Red	Clear	1 Pc.	Card

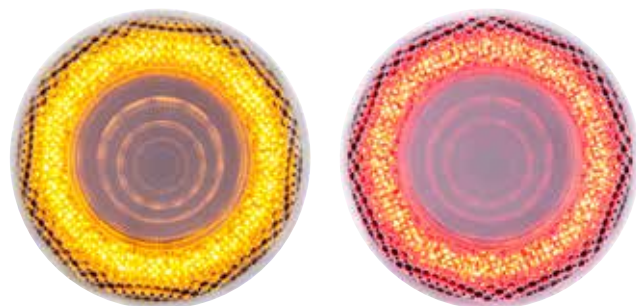

CLEARANCE MARKER LIGHTS



6 LED 2" Round GloLight

DESCRIPTION

- Polycarbonate lens sonically sealed to housing to prevent moisture intrusion
- Electronics completely sealed in epoxy to resist corrosion and moisture
- Vivid glow effect, US D734,515
- Bright LEDs with quality lens, works on all 12V DC systems
- Rear plastic housing with 2-pin female contact plug
- Recommends use with 2-pin male plugs with wire leads, item #34210 (not included)
- DOT/SAE, FMVSS 108
- IP67 water resistant rating

Item #	LEDs	Lens	Pack	Card
37035	6 Amber	Amber	1 Pc.	Card
37036	6 Red	Red	1 Pc.	Card
37035B	6 Amber	Amber	1 Pc.	Bulk
37036B	6 Red	Red	1 Pc.	Bulk
37035BAK	6 Amber	Amber	1 Kit	Bulk
37036BAK	6 Red	Red	1 Kit	Bulk

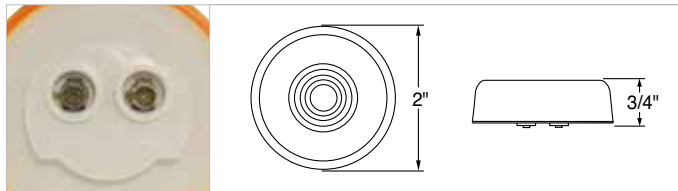

9 LED 2-1/2" Round GloLight (Clearance/Marker)

DESCRIPTION

- 15 LED 2-3/8" round Harley signal light with 1157 plug
- Fits original Harley Davidson housing
- Fits various years & models that uses 2-3/8" round signal light
- Load resistor may be required for proper installation, item #34205

Item #	LEDs	Lens	Pack	Card
37016	9 Amber	Amber	1 Pc.	Card
37017	9 Red	Red	1 Pc.	Card
37018	9 Amber	Clear	1 Pc.	Card
37019	9 Red	Clear	1 Pc.	Card
37016B	9 Amber	Amber	1 Pc.	Bulk
37017B	9 Red	Red	1 Pc.	Bulk
37016BAK	9 Amber	Amber	1 Kit	Bulk
37017BRK	9 Red	Red	1 Kit	Bulk

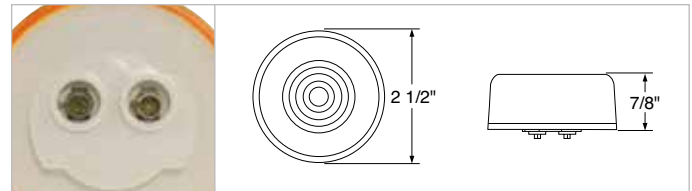

9 LED 2" Round Light (Clearance/Marker) (40-Pack)

DESCRIPTION

- Polycarbonate lens sonically sealed to housing to prevent moisture intrusion
- Bright LEDs with quality lens
- Super bright energy efficient LED w/ epoxy sealed electronics
- Easy wiring with 2 female bullet plugs
- Recommended male plug pigtail, item #34210
- Large quantity pack, 40 lights

Item #	LEDs	Lens	Pack	Box
38170CB	9 Amber	Amber	40 Pc.	CBox
38171CB	9 Red	Red	40 Pc.	CBox
38362CB	9 Amber	Clear	40 Pc.	CBox
38363CB	9 Red	Clear	40 Pc.	CBox

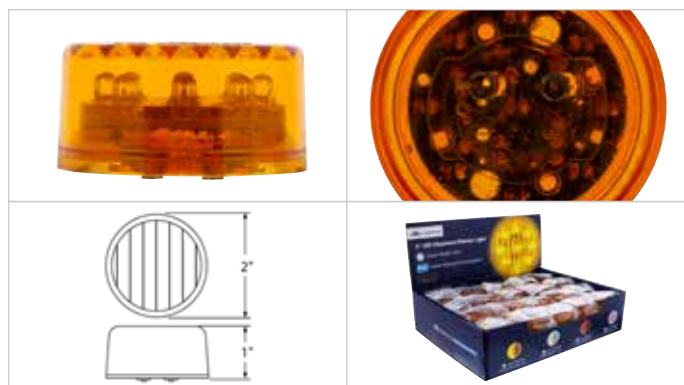

9 LED 2" (Clearance/Marker) Light - Flat

DESCRIPTION

- 2" Flat LED Clearance/Marker Light with 9 LEDs
- Available in Colored or Clear Lens with 2 Female Terminals
- Recommended Plug: Item # 34210, [Lifetime Warranty](#)

Item #	LEDs	Lens	Pack	Carton
38171	9 Amber	Amber	1 Pc.	Card
38171B	9 Red	Red	1 Pc.	Card
38170BAK	9 Amber	Amber	1 Kit	Bulk
38171BRK	9 Red	Red	1 Kit	Bulk



7 LED 2" (Clearance/Marker) Light - Reflector

DESCRIPTION

- Polycarbonate lens sonically sealed to housing to prevent moisture intrusion
- Bright LEDs, works on all 12V DC systems
- Rear plastic housing with 2-pin female contact terminal
- Recommend use with 2-pin male plug, item #34210, 34215 (not included)
- Recommend mount with rubber push-in grommet, item #31505 (not included)
- DOT/SAE, FMVSS 108, IP67 water resistant rating

Item #	LEDs	Lens	Pack	Carton
39984B	7 Amber	Amber	1 Pc.	Bulk
39985B	7 Red	Red	1 Pc.	Bulk
39984BAK	7 Amber	Amber	1 Kit	Bulk
39985BRK	7 Red	Red	1 Kit	Bulk



CLEARANCE MARKER LIGHTS

9 LED 2" (Clearance/Marker) Light - Reflector

DESCRIPTION

- 9 LED 2" Clearance/Marker Light with Reflector
- Available in Colored or Clear Lens with 2 Female Terminals
- Recommended Plug: Item # 34210, **Lifetime Warranty**

Item #	LEDs	Lens	Pack	Carton
38849B	9 Amber	Amber	1 Pc.	Bulk
38850B	9 Red	Red	1 Pc.	Bulk
38849BAK	9 Amber	Amber	1 Kit	Bulk
38850BRK	9 Red	Red	1 Kit	Bulk



4 LED 2" Round Low Profile (Clearance/Marker)

DESCRIPTION

- 2" Low profile flat LED clearance/marker light with 4 LED
- Polycarbonate lens sonically sealed to housing to prevent moisture intrusion
- Available with 2 female terminals
- Recommended plug: item # 34210

Item #	LEDs	Lens	Pack	Carton
38457B	4 Amber	Amber	1 Pc.	Bulk
38458B	4 Red	Red	1 Pc.	Bulk
38457BAK	4 Amber	Amber	1 Kit	Bulk
38458BRK	4 Red	Red	1 Kit	Bulk



9 LED 2-1/2" Round Pure Reflector Light Kit (Clearance/Marker)

DESCRIPTION

- Polycarbonate lens sonically sealed to housing to prevent moisture intrusion
- Bright LEDs with quality lens
- Easy wiring with 2 female bullet plugs
- Kit includes light, grommet & plug

Item #	LEDs	Lens	Pack	Carton
39739BAK	9 Amber	Amber	1 Kit	20/Carton
39740BRK	9 Red	Red	1 Kit	20/Carton



8 LED 2-1/2" Round Reflectorize Light (Clearance/Marker)

DESCRIPTION

- Polycarbonate lens sonically sealed to housing to prevent moisture intrusion
- 8 LED 2-1/2" clearance/marker light with reflectorized lens
- Available with 2 female terminals
- Recommended plug: item # 34210
- Bright amber LEDs with quality amber lens

Item #	LEDs	Lens	Pack	Carton
38455B	8 Amber	Amber	1 Pc.	20/Carton
38456B	8 Red	Red	1 Pc.	20/Carton
38455BAK	8 Amber	Amber	1 Kit	20/Carton
38456BRK	8 Red	Red	1 Kit	20/Carton



2" Beehive Light (Clearance/Marker)

DESCRIPTION

- 2" Beehive Clearance/Marker Light with 2 Female Terminals
- Kits Include Light, Grommet (Item # 31505) and Plug (Item # 34210)
- Recommended Plug: Item # 34210

Item #	Lens	Pack	Carton
30918	Red	1 Pc.	Bulk
36701	Amber	1 Kit	Bulk



9 LED 2" Round Beehive Light (Clearance/Marker)

DESCRIPTION

- Beehive lens design gives unique limitless vision effect
- Electronics completely sealed in epoxy inside a corrosion and impact resistant housing
- Polycarbonate lens sonically sealed to housing to prevent moisture intrusion
- Mounts with standard 2" round rubber push-in grommet, item # 31505/31507
- Uses 2-pin electrical connector plug, item #34210
- Works with any 12V DC system

Item #	LEDs	Lens	Pack	Carton
38168B	9 Amber	Amber	1 Pc.	20/Carton
38169B	9 Red	Red	1 Pc.	20/Carton



13 LED 2-1/2" Round Light (Clearance/Marker)

DESCRIPTION

- Polycarbonate lens sonically sealed to housing to prevent moisture intrusion
- Quality bright LEDs with sealed plastic rear housing
- Easy wiring with 2 female bullet plugs
- Recommended mounting grommet, item #31503
- Recommended male plug pigtail, item #34210

Item #	LEDs	Lens	Pack	Carton
38176B	13 Amber	Amber	1 Pc.	Bulk
38177B	13 Red	Red	1 Pc.	Bulk
38176BAK	13 Amber	Amber	1 Kit	Bulk
38177BRK	13 Red	Red	1 Kit	Bulk



4 LED 2-1/2" Round Low Profile Light (Clearance/Marker)

DESCRIPTION

- 2 1/2" Low Profile Flat LED Clearance/Marker Light with 4 LEDs
- Available in Colored or Clear Lens with 2 Female Terminals
- Recommended Plug: Item # 34210

Item #	LEDs	Lens	Pack	Carton
38465B	4 Amber	Amber	1 Pc.	Bulk
38466B	4 Red	Red	1 Pc.	Bulk
38465BAK	4 Amber	Amber	1 Kit	Bulk



CLEARANCE MARKER LIGHTS

4 LED Saber Rectangular Marker Light

DESCRIPTION

- Unique LED light track technology with 4 SMD LEDs and quality lens
- Includes beautiful chrome plated bezel
- Full epoxy sealed and IP67 rated for dust and water protection
- 12V DC 2-wire hookup using 0.180" bullet plugs
- Surface mount, mounting holes are approximately 4-13/16" apart
- DOT/SAE, P2

Item #	LEDs	Lens	Pack	Card
36819	4 Amber	Amber	1 Pc.	Card
36820	4 Red	Red	1 Pc.	Card

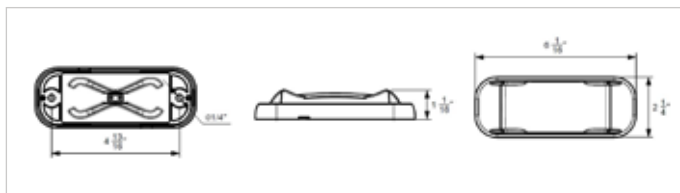

16 LED Reflector Light (Clearance/Marker) With Chrome Bezel

DESCRIPTION

- Polycarbonate lens sonically sealed to housing to prevent moisture intrusion
- High quality chrome bezel for durability and shine
- Unique reflector design projects light in multiple directions
- Surface mount, 4-7/8" spacing between 2 mounting holes center-to-center
- Wiring color code: Black=Positive, White=Ground
- DOT/SAE, P2 and PC
- Lifetime warranty
- IP67 water resistant

Item #	LEDs	Lens	Pack	Card
36893	16 Amber	Amber	1 Pc.	Card
36894	16 Red	Red	1 Pc.	Card
36895	16 Amber	Clear	1 Pc.	Card
36896	16 Red	Clear	1 Pc.	Card



8 LED Rectangular Light (Clearance/Marker) With Reflex Lens

DESCRIPTION

- High quality polycarbonate lens w/ epoxy sealed circuit board
- Reflex reflective lens design for safety and visibility in low light conditions
- 12V DC, hard wired with two .180" bullet terminals
- Recommended plug, item # 34203, 34250
- DOT/SAE, FMVSS 108
- IP67 water resistant

Item #	LEDs	Lens	Pack	Carton
38259B	8 Red	Red	1 Pc.	Bulk

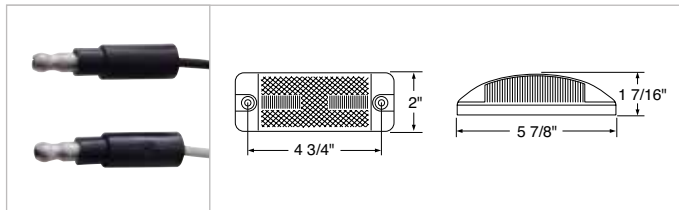

14 LED Rectangular Light (Clearance/Marker)

DESCRIPTION

- 14 LED rectangular clearance/marker light
- Polycarbonate lens sonically sealed to housing to prevent moisture intrusion
- Hard wired with two .180 bullet plugs

Item #	LEDs	Lens	Pack	Carton
39904B	14 Amber	Amber	1 Pc.	Bulk
39905B	14 Red	Red	1 Pc.	Bulk

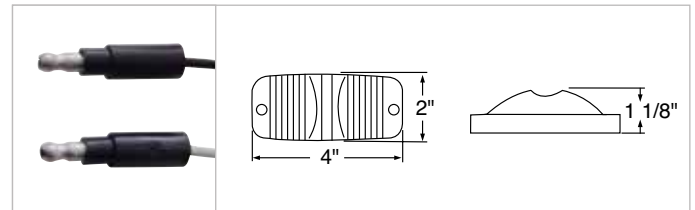
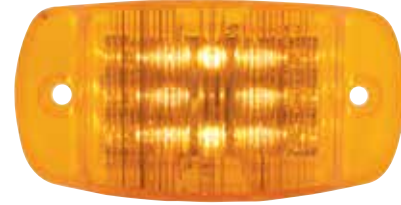

6 LED Rectangular Fender Mount Light (Clearance/Marker)

DESCRIPTION

- Polycarbonate lens sonically sealed to housing to prevent moisture intrusion
- Dual color lens with 3 amber and 3 red LED
- Recommend mounting/quick-connect base: item #30919 (chrome) or #33006 (black)
- Lifetime warranty

Item #	LEDs	Lens	Pack	Carton
36774B	6	Amber / Red	1 Pc.	Bulk
36774BARK-B	6	Amber / Red	1 Kit	Bulk



CLEARANCE MARKER LIGHTS

Rectangular Light Kit (Clearance/Marker) With Chrome Bracket

DESCRIPTION

- Rectangular clearance/marker light with 2 bulbs
- Kit includes light, bracket (item #30919) with wire leads

Item #	LEDs	Lens	Bracket	Pack
30051AK-C	5 Amber	Amber	Chrome	Card
30055RK-C	5 Red	Red	Chrome	Card

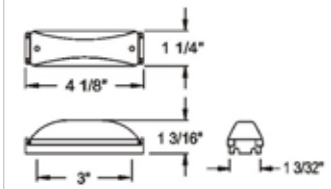
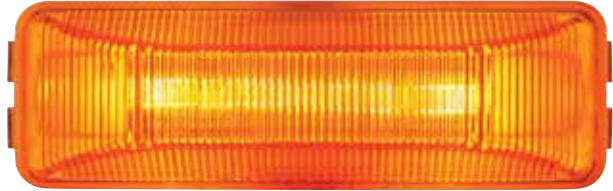

Rectangular Light Kit (Clearance/Marker) With Black or Chrome Bracket

DESCRIPTION

- Incandescent rectangular clearance/marker light kit with 1 bulb and 2 female terminals
- Polycarbonate lens sonically sealed to housing to prevent moisture intrusion
- Black kit includes light, bracket (item # 33003b) w/ lead wire
- Chrome kit includes light, bracket (item # 33002) w/ lead wire

Item #	LEDs	Lens	Bracket	Pack
30145RK-B	5 Red	Red	Black	Bulk
30145RK-C	5 Red	Red	Chrome	Bulk

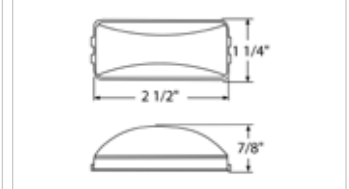

Small Narrow-Rail Light (Clearance/Marker) - Amber Lens

DESCRIPTION

- Gray molded plastic housing eliminates rust and corrosion
- Single lead wire and grounds through mounting screw

Item #	Light	Lens	Pack	Bulk
36022	Amber	Amber	1 Pc.	Bulk





16 LED Rectangular GloLight (Clearance/Marker)

DESCRIPTION

- Polycarbonate lens sonically sealed to housing to prevent moisture intrusion
- Unique patented vivid glowing design, US patent #D735,910
- Bright LEDs with slim side profile design, 11/16" tall
- 12V DC, hardwired with 2 wires
- DOT/SAE, FMVSS 108, IP67 water resistant

Item #	LEDs	Lens	Pack	Carton
36976	16 Amber	Amber	1 Pc.	1 Pc.
36977B	16 Red	Red	1 Pc.	Bulk
36977	16 Red	Red	1 Pc.	1 Pc.
36977B	16 Red	Red	1 Pc.	Bulk

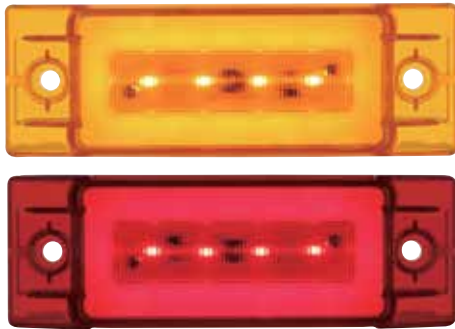

12 LED Rectangular Light (Clearance/Marker)

DESCRIPTION

- Polycarbonate lens epoxy sealed to rear cover to prevent moisture intrusion
- Solid state circuit board design for 12V DC system
- DOT/SAE P2, FMVSS 108
- Recommended mounting base: item #30919, 33006

Item #	LEDs	Lens	Pack	Carton
38161B	12 Amber	Amber	1 Pc.	Bulk
38162B	12 Red	Red	1 Pc.	Bulk
38161BAK-B	12 Amber	Amber	1 Kit	Bulk
38162BAK-B	12 Red	Red	1 Kit	Bulk



10 LED Rectangular GloLight (Clearance/Marker)

DESCRIPTION

- Polycarbonate lens sonically sealed to housing to prevent moisture intrusion
- Unique GloLight design with bright LEDs.
- Recommended plug: item #30919/33006.

Item #	LEDs	Lens	Pack	Card
36992	10 Amber	Amber	1 Pc.	Card
36992B	10 Amber	Amber	1 Pc.	Bulk
36993	10 Red	Red	1 Pc.	Card
36993B	10 Red	Red	1 Pc.	Bulk
36995	10 Red	Clear	1 Pc.	Card



6 LED Rectangular Light (Clearance/Marker)

DESCRIPTION

- Feature 6 bright LEDs with quality polycarbonate lens
- Full epoxy sealed 12V electronics, DOT/SAE, FMVSS 108

Item #	LEDs	Lens	Pack	Carton
38158B	6 Amber	Amber	1 Pc.	Bulk
38159B	6 Red	Red	1 Pc.	Bulk



Turbine Light

16 LED 4" Round Turbine Light (Stop, Turn & Tail) & (Turn Signal)

DESCRIPTION

- Polycarbonate lens sonically sealed to housing to prevent moisture intrusion
- Electronics completely sealed in epoxy to resist corrosion and moisture
- Energy efficient solid-state circuit board engineered for 12V DC systems, 16 bright SMD type LEDs
- Unique turbine fin design on outer rim, comes on low function
- High function both outer and inner LEDs turns on
- 3-pin female contact terminal, recommend use with 3-pin male plug, item #34212, 34216 (not included)
- Recommend mount with rubber push-in grommet, item #31515 (not included)
- DOT/SAE, FMVSS 108, IP67 water resistant rating
- Amperage draw on high function: 3.2mA, low function: 1.3mA

Item #	LEDs	Lens	Function	Pack
39214	16 Red	Red	S/T/T	Card
39215	16 Amber	Amber	Turn Signal	Card

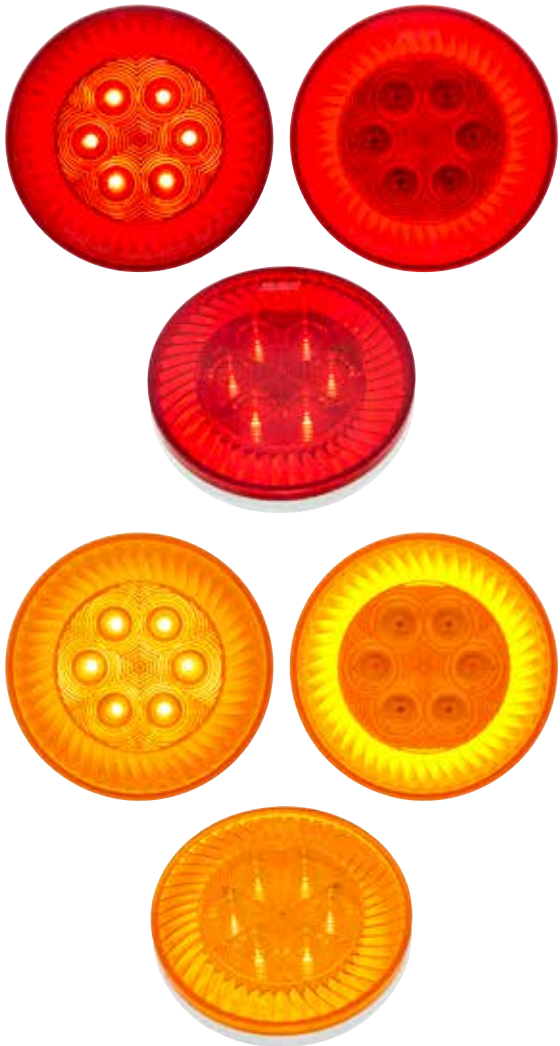

GloLight™

21 LED 4" Round GloLight (Stop, Turn & Tail) & (Turn Signal)

DESCRIPTION

- Polycarbonate lens sonically sealed to housing to prevent moisture intrusion
- Bright LEDs with vivid glow effect, patented GloLight design D763491
- Fully sealed electronics, works on all 12V DC systems
- Rear plastic housing with 3-pin female contact terminal
- Recommend use with 3-pin male plug, item #34212, 34216 (not included)
- Recommend mount with rubber push-in grommet, item #31515 (not included)
- DOT/SAE, FMVSS 108, IP67 water resistant rating

Item #	LEDs	Lens	Function	Pack
37132	21 Red	Red	S/T/T	Card
37133	21 Amber	Amber	Turn Signal	Card
37134	21 Red	Clear	S/T/T	Card
37135	21 Amber	Clear	Turn Signal	Card
37132B	21 Red	Red	1 Pc.	Bulk
37133BAK	21 Amber	Amber	1 Kit	Bulk
37132BRK	21 Red	Red	1 Kit	Bulk

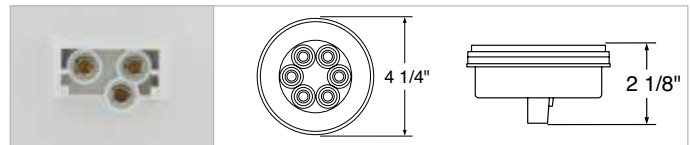



24 LED 4” Round Mirage Light (Stop, Turn & Tail) & (Turn Signal)

DESCRIPTION

- Mirage lens design gives unique limitless mirror effect
- Polycarbonate lens sonically sealed to housing to prevent moisture intrusion
- Bright LED with quality polycarbonate lens
- Durable plastic housing with 3 contact female plug
- Works with any 12V DC system
- Uses 3-pin electrical connector plug, item # 34212/34216
- Mounts with standard 4” round rubber push-in grommet, item # 31515
- DOT/SAE, FMVSS 108, **Lifetime warranty**

Item #	LEDs	Lens	Function	Pack
36652	Red	Red	S/T/T	Card
36652B	Red	Red	S/T/T	Bulk
36653	Amber	Amber	Turn Signal	Card
36654	Red	Clear	S/T/T	Card
36654B	Red	Clear	S/T/T	Bulk
36655	Amber	Clear	Turn Signal	Card



4” Round Combo Light With 12 LED (Stop, Turn & Tail) & 16 LED (Back-Up)

DESCRIPTION

- 4 round stop/turn/tail light with back-up function
- Polycarbonate lens sonically sealed to housing to prevent moisture intrusion
- 3 contact female plug
- DOT/SAE, FMVSS 108
- Recommended plug: item # 34211/34212/34216
- **Lifetime warranty**

Item #	LEDs	Lens	Pack	Pack
36607	Red/White	Red	1 Pc.	Card
36608	Red/White	Clear	1 Pc.	Card



LED S/T/T, P/T/C LIGHTS

21 LED "Competition Series" 4" Round Light (Stop, Turn & Tail)

DESCRIPTION

- Polycarbonate lens sonically sealed to housing to prevent moisture intrusion
- Bright LEDs with quality lens, work on all 12V DC system
- Rear plastic housing with 3-pin female contact terminals
- Recommend use with 3-pin male plug, item #34212, 34216 (not included)
- Recommend mount with rubber push-in grommet, item #31515 (not included)
- DOT/SAE, FMVSS 108, IP67 water resistant rating

Item #	LEDs	Lens	Function	Pack
39821	21 Red	Red	S/T/T	Card
39207	21 Red	Clear	S/T/T	Card

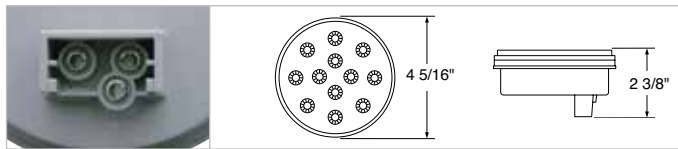

12 LED 4" Round Reflector Light (Stop, Turn & Tail) Red LED/Red Lens

DESCRIPTION

- Polycarbonate lens sonically sealed to housing to prevent moisture intrusion
- Bright red LEDs with chrome inner reflectors
- 12V DC, rear plastic housing w/ 3-pin female contact terminal
- Recommend use with 3-pin male plug, item # 34212, 34216 (not included)
- Recommend mount with rubber push-in grommet, item # 31515 (not included)

Item #	LEDs	Lens	Pack	Carton
38116B	12 Red	Red	1 Pc.	Bulk
38116BRK	12 Red	Red	1 Kit	Bulk



10 LED 4" (Stop, Turn & Tail) & (Turn Signal)

DESCRIPTION

- Quality polycarbonate lens with 10 bright LEDs
- Epoxy coated, fully sealed electronics
- Solid state circuit board design for 12V DC system
- Hardwired with 3-pin female bullet plug
- Recommend use with 3-pin male plug, item #34212, 34216 (not included)
- Recommend mount with rubber push-in grommet, item #31515 (not included)
- DOT/SAE, FMVSS 108, IP67 water resistant rating

Item #	LEDs	Lens	Function	Carton
38771B	10 Amber	Amber	Turn Signal	Bulk
38770B	10 Red	Red	S/T/T	Bulk
38771BAK	10 Amber	Amber	Turn Signal	Bulk
38770BRK	10 Red	Red	S/T/T	Bulk



10 LED 4" Round Reflex Flange Mount Light (Stop, Turn & Tail) - Red LED/Red Lens

DESCRIPTION

- 10 LED 4" S/T/T light with reflex flange
- Polycarbonate lens sonically sealed to housing to prevent moisture intrusion
- Red LED with red lens
- Flange mount, Hard wired with 3 contact female plug
- Recommended plug: item # 34212/34216

Item #	LEDs	Lens	Pack	Carton
39656B	10 Red	Red	1 Pc.	Bulk

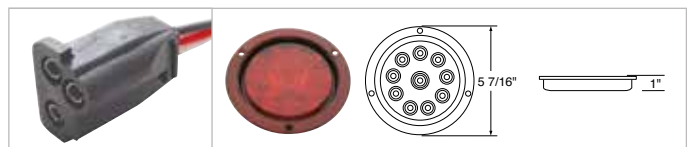



18 LED 4" GloLight (Stop, Turn & Tail) & (Turn Signal)

DESCRIPTION

- Unique patented "GLO" design, halo effect on running, all LED lit on stop
- Polycarbonate lens sonically sealed to housing to prevent moisture intrusion
- Electronics completely sealed in epoxy to resist corrosion and moisture
- Bright red LEDs with quality red lens, work on all 12V DC system.
- Rear plastic housing with 3-pin female contact plug
- Recommends use with 3-pin male connector plug, item 34212/34216 (not included)
- Recommends mounting with 4" round rubber push-in grommet, item # 31515 (not included)
- Lifetime warranty

Item #	LEDs	Lens	Function	Pack
36922	18 Red	Red	S/T/T	Card
36923	18 Amber	Amber	Turn Signal	Card
36922B	18 Red	Red	S/T/T	Bulk
36923B	18 Amber	Amber	Turn Signal	Bulk
36922BRK	18 Red	Red	S/T/T	Bulk
36923BAK	18 Amber	Amber	Turn Signal	Bulk



7 LED 4" Competition Series (Stop, Turn & Tail) & (Turn Signal)

DESCRIPTION

- 7 LED 4" "Competition Series" S/T/T Light
- Recommended Plug: Item # 34212/34216, [Lifetime Warranty](#)

Item #	LEDs	Lens	Function	Carton
39119B	7 Amber	Amber	Turn Signal	Bulk
39117B	7 Red	Red	S/T/T	Bulk
39119BAK	7 Amber	Amber	Turn Signal	Bulk
39117BRK	7 Red	Red	S/T/T	Bulk



12 LED 4" Round Light Kit (Stop, Turn & Tail) Red LED/Red Lens

DESCRIPTION

- 12 LED 4" round S/T/T light
- Polycarbonate lens sonically sealed to housing to prevent moisture intrusion
- Red LED with red lens
- 3 contact female terminal
- Recommended plugs: item # 34212/34216
- Kit includes light, grommet (item # 31515) and plug (item # 34212)

Item #	LEDs	Lens	Function	Pack
38112BRK	12 Red	Red	S/T/T	Card



Kit (Item # 38112BRK) Includes



LED S/T/T, P/T/C LIGHTS

30 LED 4" Round Light (Stop, Turn & Tail) Red LED/Red Lens

DESCRIPTION

- Polycarbonate lens sonically sealed to housing to prevent moisture intrusion
- Bright red LEDs with quality red lens
- Easy wiring with 3 female bullet plugs
- Recommended male plug pigtail, item # 34212/34216
- Available in retail packaging

Item #	LEDs	Lens	Function	Pack
36832	30 Red	Red	S/T/T	Card
36832B	30 Red	Red	S/T/T	Bulk
36832BRK	30 Red	Red	S/T/T	Kit



21 LED 4" (Stop, Turn & Tail) - Competition Series

DESCRIPTION

- 21 LED 4" Round Competition Series S/T/T Light
- Available in Red or Clear Lens, 3 Contact Female Terminal
- Recommended Plug: Item # 34212/34216, [Lifetime Warranty](#)

Item #	LEDs	Lens	Pack	Carton
39821	21 Red	Red	1 Kit	20/Carton

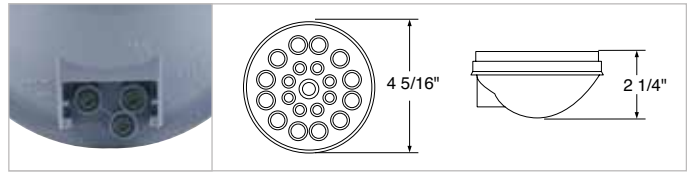

16 LED 4" Reflector Turn Signal Light

DESCRIPTION

- Polycarbonate lens sonically sealed to housing to prevent moisture intrusion
- Bright LEDs with chrome inner reflectors, works on all 12V DC
- Rear plastic housing with 3-pin female contact terminal
- Recommend use with 3-pin male plug, item #34212, 34216 (not included)
- Recommend mount with rubber push-in grommet, item #31515 (not included)
- DOT/SAE, FMVSS 108, IP67 water resistant rating.

Item #	LEDs	Lens	Pack	Carton
39343	16 Amber	Amber	1 Pc.	Card

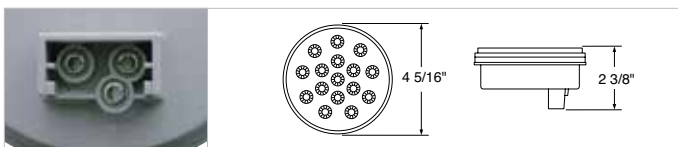

7 LED 4" Round Reflector Light (Stop, Turn & Tail) & (Turn Signal)

DESCRIPTION

- Polycarbonate lens sonically sealed to housing to prevent moisture intrusion
- Rear plastic housing with 3 contact female terminal, 12V
- Recommend use with 3-pin male plug, item #34212, 34216 (not included)
- DOT/SAE, FMVSS108, IP67 water resistant.

Item #	LEDs	Lens	Function	Carton
39924B	7 Red	Red	S/T/T	Bulk
39973BAK	7 Amber	Amber	Turn	Bulk
39924BRK	7 Red	Red	S/T/T	Bulk

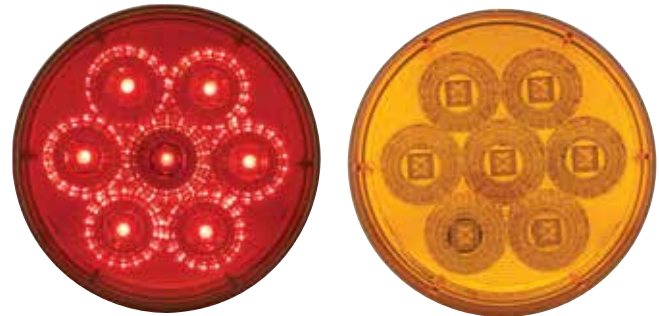



21 LED 4" Round Flange Mount GloLight (Stop, Turn & Tail) & (Turn Signal)

DESCRIPTION

- Polycarbonate lens sonically sealed to housing to prevent moisture intrusion
- Bright LEDs with vivid glow effect, patented GloLight design D743491
- Fully sealed electronics, work on all 12V DC system
- Flange mount design, no grommet needed
- Rear plastic housing with 3-pin female contact terminal
- Recommend use with 3-pin male plug, item #34212, 34216 (not included)
- DOT/SAE, FMVSS 108, IP67 water resistant rating.

Item #	LEDs	Lens	Function	Pack
36957	21 Red	Red	S/T/T	Card
36958	21 Amber	Amber	Turn Signal	Card



7 LED 4" Round Stainless Steel Flange Light (Stop, Turn & Tail) & (Turn Signal)

DESCRIPTION

- Highly polished stainless steel mounting flange for ease of installation, durability and shine
- Polycarbonate lens sonically sealed to housing to prevent moisture intrusion
- Bright energy efficient LEDs, work on all 12V DC system
- Rear plastic housing with 3-pin female contact terminal
- Recommend use with 3-pin male plug, item #34212, 34216 (not included)
- DOT/SAE, FMVSS 108

Item #	LEDs	Lens	Function	Pack
36913	7 Red	Red	S/T/T	Card
36914	7 Red	Clear	S/T/T	Card
36915	7 Amber	Amber	Turn Signal	Card



12 LED 4" Round Flange Mount Light (Stop, Turn & Tail) - Red LED/Red Lens

DESCRIPTION

- New stainless steel deep dish housing with bubble lens
- Easy to install with flange mount design, no grommet needed
- 12 super bright LED, Hard wired with 3 contact female plug
- Recommended plug: item # (34212)

Item #	LEDs	Lens	Pack	Carton
38061B	12 Red	Red	1 Pc.	20/Carton

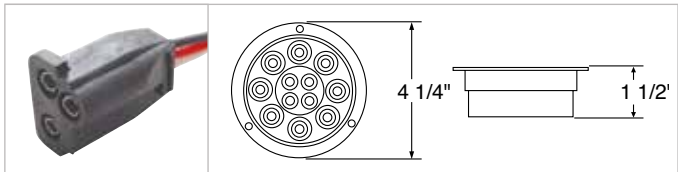

LED S/T/T, P/T/C LIGHTS

7 LED 4" Round Competition Series (Stop, Turn & Tail) & (Turn Signal)

DESCRIPTION

- High quality polycarbonate lens w/ epoxy sealed circuit board
- 12V DC, rear plastic housing with 3 contact female terminal
- Recommend use with 3-pin male plug, item #34212, 34216 (not included)
- DOT/SAE, FMVSS108, IP67 water resistant

Item #	LEDs	Lens	Function	Pack
39117	7 Red	Red	S/T/T	Card
39118	7 Red	Clear	S/T/T	Card
39118B	7 Red	Clear	S/T/T	Bulk
39119	7 Amber	Amber	Turn Signal	Card
39120	7 Amber	Clear	Turn Signal	Card



GloLight™

32 LED 7" GloLight (Stop, Turn & Tail) & (Turn Signal)

DESCRIPTION

- 32 bright amber LEDs with unique "GLO" style center ring
- Triple functions, can be use as parking, turn signal, or clearance light. Perfect for bus application
- 3 wires (1 wire with ring terminal)

Item #	LEDs	Lens	Function	Pack
37033	32 Amber	Amber	Turn Signal	Card
37034	32 Red	Red	S/T/T	Card

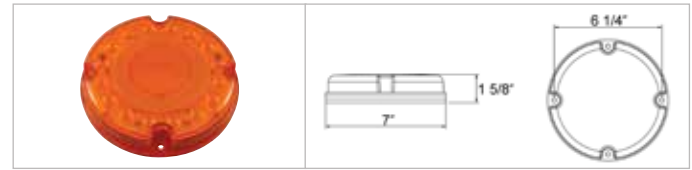
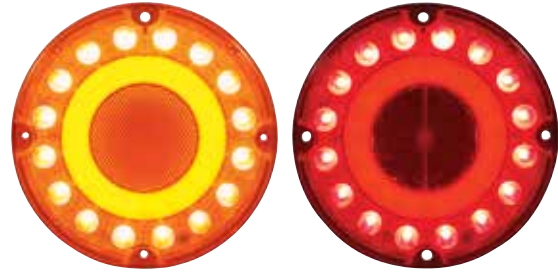

17 LED 7" (Stop, Turn & Tail) & (Turn Signal)

DESCRIPTION

- 17 LED 7" Round S/T/T & P/T/C Light
- Available in Amber or Red Lens, Perfect for Bus Application
- 3 Wires (1 Wire with Ring Terminal), **Lifetime Warranty**

Item #	LEDs	Lens	Function	Pack
39960B	17 Amber	Amber	Turn Signal	Bulk
39961B	17 Red	Red	S/T/T	Bulk

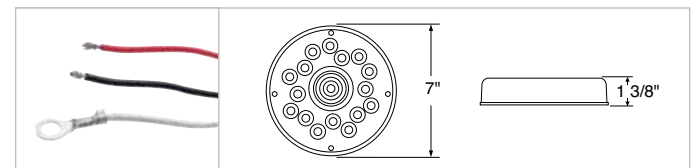
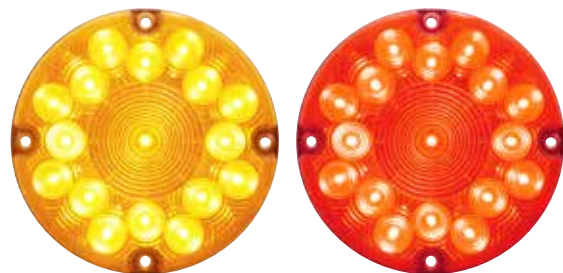

Turbine Light

**20 LED 6" Oval Turbine Light
(Stop, Turn & Tail) & (Turn Signal)**

DESCRIPTION

- Polycarbonate lens sonically sealed to housing to prevent moisture intrusion
- Electronics completely sealed in epoxy to resist corrosion and moisture
- Energy efficient solid-state circuit board engineered for 12V DC systems, feature 20 bright SMD type LEDs
- Unique turbine fin design on outer rim, comes on with low function
- High function both outer and inner LEDs turns on
- Rear housing with 3-pin female contact terminal
- Recommend use with 3-pin male plug, item #34212, 34216 (not included)
- Recommend mount with rubber push-in grommet, item #31506 (not included)
- DOT/SAE, FMVSS 108, IP67 water resistant rating

Item #	LEDs	Lens	Function	Pack
39218	20 Red	Red	S/T/T	Card
39219	20 Amber	Amber	Turn Signal	Card

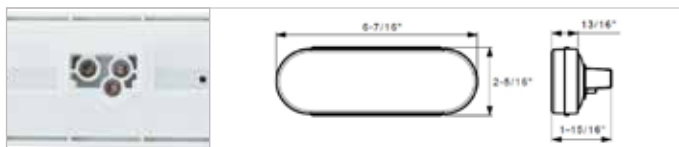

Abyss Light™

**22 LED 6" Oval Abyss Light
(Stop, Turn & Tail) & (Turn Signal)**

DESCRIPTION

- Polycarbonate lens sonically sealed to housing to prevent moisture intrusion
- Epoxy coated, fully sealed electronics designed for 12V DC systems
- Abyss lens design gives unique infinity vision effect
- Corrosion and impact resistant plastic housing with 3 contact female plug
- Recommend use with 3-pin electrical plug, item #34212, 34216
- Recommend mount w/ 6" oval rubber grommet, item #31506

Item #	LEDs	Lens	Function	Pack
36569	22 Red	Red	S/T/T	Card
36570	22 Amber	Amber	Turn Signal	Card
36571	22 Red	Clear	S/T/T	Card
36572	22 Amber	Clear	Turn Signal	Card

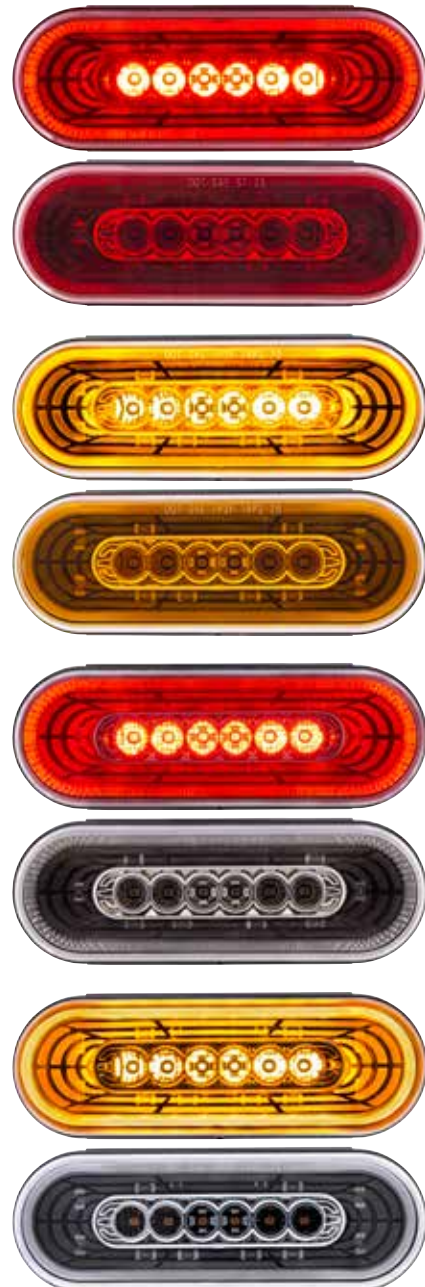

Mirage

24 LED 6" Oval Mirage Light (S/T/T) & (Turn Signal)

DESCRIPTION

- Mirage lens design gives unique limitless mirror effect
- Polycarbonate lens sonically sealed to housing to prevent moisture intrusion
- Durable plastic housing with 3 contact female plug
- Recommended plug, item#34212/34216
- Mounts w/6" oval rubber push-in grommet item #31506
- Works with any 12V DC system
- DOT/SAE, FMVSS 108, Lifetime warranty

Item #	LEDs	Lens	Function	Pack
36656	Red	Red	S/T/T	Card
36657	Amber	Amber	Turn Signal	Card
36664	Red	Clear	S/T/T	Card
36665	Amber	Clear	Turn Signal	Card



6 LED Oval Light Kit (Stop, Turn & Tail) - Red LED/Red Lens

DESCRIPTION

- 6 LED 6" oval S/T/T light
- Polycarbonate lens sonically sealed to housing to prevent moisture intrusion
- Red LED with red lens
- Hard wired with 3 contact female plug
- Recommended plug: item # 34212/34216
- Kit includes light, grommet (item # 31506) and plug (item # 34216)

Item #	LEDs	Lens	Function	Pack
39654BRK	6 Red	Red	S/T/T	Card



GloLight™

22 LED 6" Oval GloLight (S/T/T) & (Turn Signal)

DESCRIPTION

- Polycarbonate lens sonically sealed to housing to prevent moisture intrusion
- Electronics completely sealed in epoxy to resist corrosion and moisture
- Bright LEDs with quality red lens, work on all 12V DC system
- Rear plastic housing with 3-pin female contact terminal
- Unique patented GloLight design D709221
- Bright red LEDs with quality clear lens, work on all 12V DC system
- Rear plastic housing with 3-pin female contact plug
- Recommend use with 3-pin male connector plug, item #34212, 34216 (not included)
- Recommend mount with rubber push-in grommet, item #31506 (not included)
- DOT/SAE, FMVSS 108, IP67 water resistant rating

Item #	LEDs	Lens	Function	Pack
37130	22 Red	Clear	S/T/T	Card
37131	22 Red	Red	Turn Signal	Card

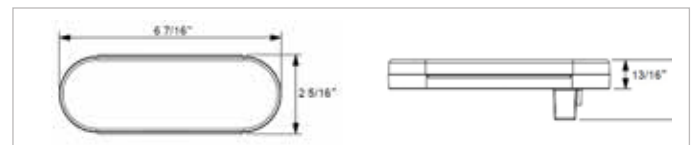

GloLight™

22 LED 6" Oval GloLight With Divider Bar Inner Design (Stop, Turn & Tail) - Red LEDs/Clear Lens

DESCRIPTION

- Polycarbonate lens sonically sealed to housing to prevent moisture intrusion
- Bright LEDs with clear lens & halo insert, works on all 12V DC system
- Rear plastic housing with 3-pin female contact terminal
- Unique patented GloLight design US9,062,845B1
- Recommend use with 3-pin male connector plug, item #34212, 34216 (not included)
- Recommend mount with rubber push-in grommet, item # 31506 (not included)

Item #	LEDs	Lens	Function	Pack
36924	22 Red	Clear	S/T/T	Card



GloLight™

22 LED 6" Oval Clear Lens With Halo Insert GloLight Light (Stop, Turn & Tail) & (Turn Signal)

DESCRIPTION

- Polycarbonate lens sonically sealed to housing to prevent moisture intrusion
- Bright LEDs with clear lens & halo insert, works on all 12V DC system
- Rear plastic housing with 3-pin female contact plug
- Unique patented GloLight design US9,062,845B1
- Recommends use with 3-pin male connector plug, item #34212/34216 (not included)
- Recommends mounting with rubber push-in grommet, item # 31506 (not included)

Item #	LEDs	Lens	Pack	Carton
36925	22 Amber	Amber	1 Pc.	Card
36925B	22 Amber	Amber	1 Pc.	Bulk
36924B	22 Red	Red	1 Pc.	Bulk
36925BAK	22 Amber	Amber	1 Kit	Bulk
36924BRK	22 Red	Red	1 Kit	Bulk

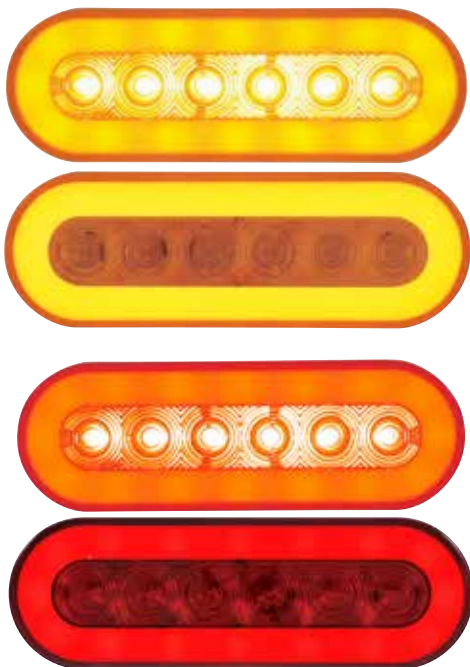
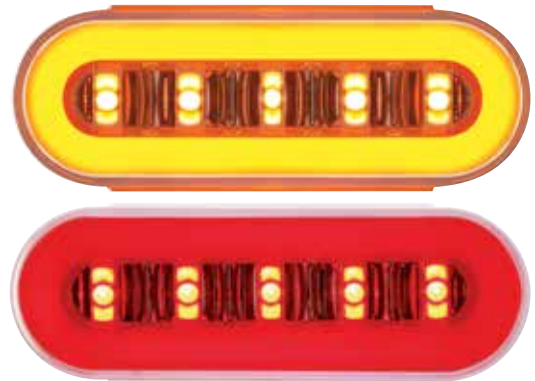

GloLight™

22 LED 6" Oval GloLight Bar Kit (S/T/T) & (Turn Signal)

DESCRIPTION

- Polycarbonate lens sonically sealed to housing to prevent moisture intrusion
- Electronics completely sealed in epoxy to resist corrosion
- Bright LEDs with quality amber lens, work on all 12V DC system
- Rear plastic housing with 3-pin female contact terminal
- Unique patented GloLight design D709221
- Kit includes 6" rubber grommet (item # 31506) and 3-pin pigtail plug (item # 34212)
- Quality black grommet included for light mounting, also provides shock and vibration protection
- DOT/SAE, FMVSS 108, IP67 water resistant rating.

Item #	LEDs	Lens	Function	Pack
37129BAK	22 Amber	Amber	Turn Signal	Bulk
37128BRK	22 Red	Red	S/T/T	Bulk



LED S/T/T, P/T/C LIGHTS

12 LED 6" Oval Reflector Light (Stop, Turn & Tail)

DESCRIPTION

- Polycarbonate lens sonically sealed to housing to prevent moisture intrusion
- Bright red LEDs with chrome inner reflectors
- 12V DC, rear plastic housing with 3-pin female contact terminal
- Recommend use with 3-pin male plug, item # 34212, 34216 (not included)
- Recommend mount with rubber push-in grommet, item # 31506 (not included)

Item #	LEDs	Lens	Pack	Carton
38121B	12 Red	Red	1 Pc.	Bulk
38121BRK	12 Red	Red	1 Kit	Bulk



Oval Crystal Light (Stop, Turn & Tail) - Red Lens

DESCRIPTION

- Incandescent oval crystal stop, turn & tail & light with 3 contact female terminal
- Multi-faced reflective surface produces multiple points of peak illumination
- Recommended plug: item # 34212

Item #	Bulb	Lens	Pack	Bulk
33539B	Red	Red	1 Pc.	Bulk



10 LED Oval Light (Stop, Turn & Tail) - Red LED/Red Lens

DESCRIPTION

- 10 LED 6" oval S/T/T light
- Polycarbonate lens sonically sealed to housing to prevent moisture intrusion
- Red LED with red lens
- 3 contact female terminal
- Recommended plug item # (34212/34216)

Item #	LEDs	Lens	Pack	Pack
36771B	10 Red	Red	1 Pc.	Bulk
36771BRK	10 Red	Red	1 Kit	Kit



7 LED Oval Light (Stop, Turn & Tail)

DESCRIPTION

- 6" oval stop, turn & tail light with 7 red LED w/red lens
- Polycarbonate lens sonically sealed to housing to prevent moisture intrusion
- Red LED with clear lens
- 3 contact female terminal
- Recommended plug: item # 34212/34216
- Available in retail packaging

Item #	LEDs	Lens	Function	Pack
36855	7 Red	Red	S/T/T	Card
36857	7 Red	Clear	S/T/T	Card



6" Oval Combo Light With 14 LED (Stop, Turn & Tail) & 16 LED (Back-Up)

DESCRIPTION

- Polycarbonate lens sonically sealed to housing to prevent moisture intrusion
- Bright LEDs with energy efficient 12V DC electronics
- Special design combination light with S/T/T and backup function
- Rear plastic housing with dual 3-pin female contact terminals
- S/T/T function recommend use with 3-pin male plug, item #34212, 34216 (not included)
- Recommend mount with rubber push-in grommet, item #31506 (not included)
- DOT/SAE, FMVSS 108, IP67 water resistant rating

Item #	Bulb	Lens	Pack	Card
36609	Red	Red	1 Pc.	Card
36610	Red	Red	1 Pc.	Card





22 LED 6" Oval Flange Mount GloLight (Stop, Turn & Tail) & (Turn Signal)

DESCRIPTION

- 7 LED 4" Round SS Flange Light (Stop, Turn & Tail) Highly Polycarbonate lens sonically sealed to housing to prevent moisture intrusion
- Vivid glow effect, patented GloLight design US9,062,845B1
- Black plastic housing with mounting flange
- 12V DC, with 3 contact female terminal
- Recommend use with plug, item #34212, 34216 (not included)
- DOT/SAE, FMVSS108; IP67 water resistant

Item #	LEDs	Lens	Function	Pack
36954	22 Amber	Amber	Turn Signal	Card
36955	22 Red	Clear	S/T/T	Card
36956	22 Amber	Clear	Turn Signal	Card

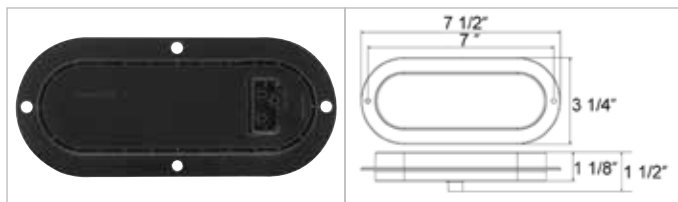

22 LED 6" Oval GloLight (Stop, Turn & Tail) & (Turn Signal)

DESCRIPTION

- Polycarbonate lens sonically sealed to housing to prevent moisture intrusion
- Electronics completely sealed in epoxy to resist corrosion and moisture
- Bright LEDs with quality red lens, work on all 12V DC system
- Rear plastic housing with 3-pin female contact terminal
- Unique patented GloLight design D709221
- Recommend use with 3-pin male plug, item #34212, 34216 (not included)
- Recommend mount with rubber push-in grommet, item #31506 (not included)
- Available in retail packaging
- DOT/SAE, FMVSS 108
- IP67 water resistant rating

Item #	LEDs	Lens	Function	Pack
37128	22 Red	Red	S/T/T	Card
37129	22 Amber	Amber	Turn Signal	Card

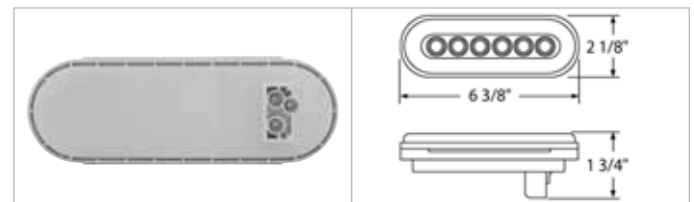

**16 LED 6" Oval Reflector (Turn Signal) Light Kit
Amber LED/Amber Lens**

DESCRIPTION

- Polycarbonate lens sonically sealed to housing to prevent moisture intrusion
- Bright LEDs with chrome inner reflectors, works on all 12V DC systems
- Rear plastic housing with 3-pin female contact terminal
- Kit includes light, grommet (item #31506) and plug (item #34215)
- DOT/SAE, FMVSS 108
- IP67 water resistant rating

Item #	LEDs	Lens	Function	Pack
39341BAK	16 Amber	Amber	Turn Signal Kit	Card



**10 LED 6" Oval (Turn Signal) Light Kit
Amber LED/Amber Lens**

DESCRIPTION

- 10 LED 6" oval P/T/C light
- Polycarbonate lens sonically sealed to housing to prevent moisture intrusion
- Amber LED with amber lens
- Mounts with standard 6" oval push-in rubber grommet, Item # 31506
- Hard wired with 3 contact female plug
- Recommended male plug: item # (34211)

Item #	LEDs	Lens	Function	Pack
38775BAK	10 Amber	Amber	Turn Signal	Card



7 LED 6" Oval (Stop, Turn & Tail)

DESCRIPTION

- 6" oval stop, turn & tail light with 7 red LED w/red lens
- Polycarbonate lens sonically sealed to housing to prevent moisture intrusion
- 3 contact female terminal
- Recommended plug: item # 34212/34216

Item #	LEDs	Lens	Function	Pack
36855B	7 Red	Red	S/T/T	Bulk
36855BRK	7 Red	Red	S/T/T	Bulk



10 LED 6" Oval Light (Stop, Turn & Tail)

DESCRIPTION

- 10 LED 6" oval S/T/T light
- Polycarbonate lens sonically sealed to housing to prevent moisture intrusion
- 3 contact female terminal
- Recommended plug item # (34212/34216)

Item #	LEDs	Lens	Pack	Carton
36771B	10 Red	Red	1 Pc.	Bulk
36771BRK	10 Red	Red	1 Kit	Bulk



LED S/T/T, P/T/C LIGHTS

8 LED Mid-Trailer (Turn Signal) Light

DESCRIPTION

- 8 amber SMD LED mid-trailer turn signal light
- Polycarbonate lens sonically sealed to housing to prevent moisture intrusion
- Amber LED with amber lens
- 3 contact female terminal
- Recommended plug: item # 34212/34216
- Recommended grommet for mounting, item 31506
- SAE/DOT P2

Item #	LEDs	Lens	Function	Pack
38922	8 Amber	Amber	Turn Signal	Card
38922B	8 Amber	Amber	Turn Signal	Bulk

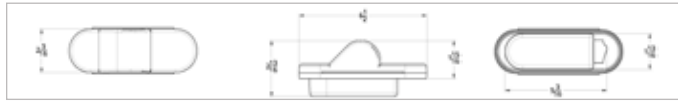

18 LED Mid-Trailer (Turn Signal) Light

DESCRIPTION

- 18 LED 6" Mid-Trailer Turn Signal Light
- Available in Amber or Clear Lens, 3 Contact Female Terminal
- Recommended Plug: Item # 34212/34216, **Lifetime Warranty**

Item #	LEDs	Lens	Pack	Carton
38920B	18 Amber	Amber	1 Pc.	Bulk
38920BAK	18 Amber	Amber	1 Kit	Bulk



10 LED Oval (Stop, Turn & Tail) & (Turn Signal) With Chrome Bezel

DESCRIPTION

- 10 LED 6" Oval S/T/T or P/T/C Light with Chrome Bezel
- Available in Colored or Clear Lens, Hard Wired with 3 Contact Female Plug
- Universal Flange Mount, Mount onto Any Flat Surface
- Recommended Plug: Item # 34212, **Lifetime Warranty**

Item #	LEDs	Lens	Pack	Carton
38901B	10 Amber	Amber	1 Pc.	Bulk
38900B	10 Red	Red	1 Pc.	Bulk



14 LED Rectangular (Stop, Turn & Tail) & (Turn Signal)

DESCRIPTION

- 14 LED Rectangular P/T/C "GLO" Light
- Available in Colored or Clear Lens, 3 Contact Terminal
- Recommended Plug: Item # 34212/34216, **Lifetime Warranty**

Item #	LEDs	Lens	Pack	Carton
36961B	14 Amber	Amber	1 Pc.	Bulk
36962B	14 Red	Red	1 Pc.	Bulk
36961BAK	14 Amber	Amber	1 Kit	Bulk
36962BRK	14 Red	Red	1 Kit	Bulk



GloLight™

54 LED Single Stud Double Face GloLight (Turn Signal)

DESCRIPTION

- Polycarbonate lens sonically sealed to housing to prevent moisture intrusion
- Electronics completely sealed in epoxy to resist corrosion and moisture
- Heavy duty chrome plated metal housing with stud mounting
- Each face features 27 bright LEDs with vivid glow effect, patented GloLight design D715976
- Straight forward wiring with 3 simple wire hook up, works on 12V DC systems
- Wiring color code: white=ground, red=high function, black=low function
- DOT/SAE, FMVSS108

Item #	LEDs	Lens	Function	Pack
37083	54 Amber & Red	Amber & Red	Turn Signal	Card
37084	54 Amber & Red	Clear	Turn Signal	Card

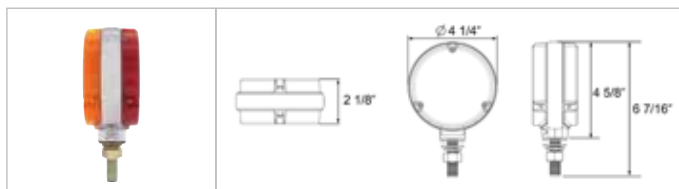

GloLight™

53 LED Double Stud Double Face GloLight With Side Marker (Turn Signal)

DESCRIPTION

- Polycarbonate lens sonically sealed to housing to prevent moisture intrusion
- Electronics completely sealed in epoxy to resist corrosion and moisture
- Beautiful chrome plated housing with metal mounting studs
- 25 bright LEDs on each main lens and 3 LEDs on side mounted lens, patented GloLight design D771286
- Straight forward wiring with 3 simple wire hook up, works on 12V DC systems
- Wiring color code: White=Ground, Red=High function, Black=Low function
- DOT/SAE, FMVSS108

Item #	LEDs	Lens	Driver/Passenger	Pack
37124	21 Red	Red	Driver Side	Card
37125	21 Amber	Amber	Passenger Side	Card

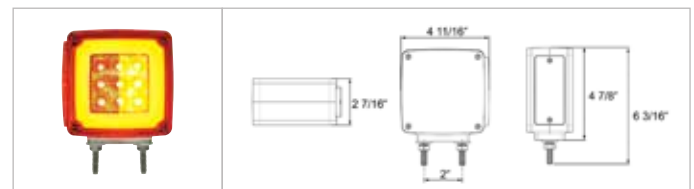

LED S/T/T, P/T/C LIGHTS

LED Reflector Universal Combination Tail Light Without License Light

DESCRIPTION

- Polycarbonate lens sonically sealed to housing to prevent moisture intrusion
- Chrome plastic visor available separately (item # 40930)
- Functions as S/T/T, clearance/marker, and back-up light
- 16 red LED (S/T/T) + 22 white LED (back-up) + 2 red LED (clearance)
- Without license light, three bolt mounts on 2" triangle pattern

Item #	LEDs	License Light	Pack	Carton
39353B	16 Red, 22 White	No	1 Pc.	Bulk



LED Universal Combination Tail Light Without License Light & Side Marker

DESCRIPTION

- Polycarbonate lens sonically sealed to housing to prevent moisture intrusion
- Three bolt mount on 2" triangle pattern
- Also fits 1979-87 Chevy and GMC Stepside truck
- Functions as S/T/T, clearance/marker, and back-up light
- 16 red LED (S/T/T) + 2 red LED (clearance/marker) + 22 white LED (back-up)
- Without license light

Item #	LEDs	License Light	Pack	Carton
38490B	16+2 Red, 22 White	No	1 Pc.	Bulk



LED Reflector Universal Combination Tail Light With License Light

DESCRIPTION

- Polycarbonate lens sonically sealed to housing to prevent moisture intrusion
- Chrome plastic visor available separately (item # 40930)
- Functions as S/T/T, clearance/marker, back-up, and license light
- 16 red LED (S/T/T) + 22 white LED (back-up) + 4 white LED (license) + 2 red LED (clearance)
- With license light, three bolt mount on 2" triangle pattern

Item #	LEDs	License Light	Pack	Carton
39354B	16 Red, 22+4 White	Yes	1 Pc.	Bulk



LED Universal Combination Tail Light With License Light & Side Marker

DESCRIPTION

- Polycarbonate lens sonically sealed to housing to prevent moisture intrusion
- Three bolt mount on 2" triangle pattern
- Also fits 1979-87 Chevy and GMC Stepside truck
- Functions as S/T/T, clearance/marker, back-up, and license light
- 16 red LED (S/T/T) + 2 red LED (clearance/marker) + 22 white LED (back-up) + 4 white LED (license)
- With license light

Item #	LEDs	License Light	Pack	Carton
38491B	16+2 Red, 22+4 White	Yes	1 Pc.	Bulk



15 LED Rectangular (Stop, Turn, Tail) & (Turn Signal)

DESCRIPTION

- 15 LED Rectangular S/T/T & P/T/C Light, Unique Lens Design
- Available in Colored or Clear Lens, 3 Contact Terminal
- Recommended Plug: Item # 34212/34216, **Lifetime Warranty**

Item #	LEDs	Lens	Pack	Carton
38746B	15 Amber	Amber	1 Pc.	Bulk
38746BAK	15 Amber	Amber	1 Kit	Bulk
38747BRK	15 Red	Red	1 Kit	Bulk



Over 80" Wide LED Reflector Submersible Combination Tail Light With License Light (Bulk)

DESCRIPTION

- Rear clearance light for over 80" wide application.
- 3 wires (white = ground, green = stop/turn, brown = tail/ marker/license).
- Lifetime warranty.

Item #	LEDs	License Light	Pack	Carton
39552B	18 + 3 Red, 5 White	Yes	1 Pc.	Bulk

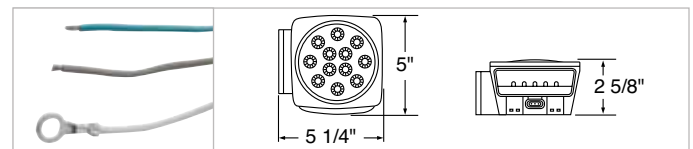

Over 80" Wide LED Submersible Combination Tail Light Without License Light

DESCRIPTION

- Polycarbonate lens sonically sealed to housing to prevent moisture intrusion
- Rear clearance light for over 80" wide application
- 3 wires (white = ground, green = stop/turn, brown = tail/ marker/license)
- Submersible combination light with 12 red LED + 4 red LED (side marker)

Item #	LEDs	License Light	Pack	Carton
38310B	12+4 Red	No	1 Pc.	Bulk

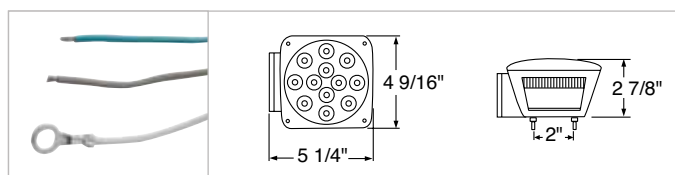

Over 80" Wide LED Submersible Combination Tail Light With License Light

DESCRIPTION

- Polycarbonate lens sonically sealed to housing to prevent moisture intrusion
- Rear clearance light for over 80" wide application
- 3 wires (white = ground, green = stop/turn, brown = tail/ marker/license)
- Submersible combination light with 12 red LED + 4 red LED (side marker) + 4 white LED (license illuminator)

Item #	LEDs	License Light	Pack	Carton
38311B	12+4 Red, 4 White	Yes	1 Pc.	Bulk

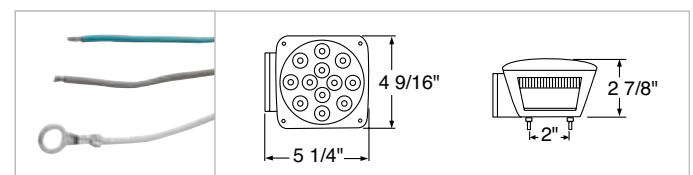



Over 80" Wide LED GloLight Submersible Combination (Tail Light) Without License Light

DESCRIPTION

- Unique patented GloLight design, halo effect on running, all LED lit on stop
- Polycarbonate lens sonically sealed to housing to prevent moisture intrusion
- Electronics completely sealed in epoxy to resist corrosion and moisture
- Fully submersible, best for boat trailer application
- Features stop, turn, and tail functions with 24 red LED + 1 red LED (side marker)
- Straight forward mounting design with two bolts, approximately 2" apart
- Easy wiring with 3 hardwired wire leads

Item #	LEDs	Lens	Function	Pack
36912	25 Red	Red	S/T/T+Backup	Card



Over 80" Wide LED Submersible Combination Tail Light Kit

DESCRIPTION

- Polycarbonate lens sonically sealed to housing to prevent moisture intrusion
- Rear clearance light for over 80" wide application
- 3 wires (white = ground, green = stop/turn, brown = tail/ marker/license)
- Submersible combination light with 24 red LED + 8 red LED (side marker) + 4 white LED (license illuminator)
- Kit includes light, bracket, item # 33098, and wires, item # 90624

Item #	LEDs	Lens	Function	Pack
38309BK	16 Red	Red	Tail Light Kit	Card



LED GloLight Universal Combination (Tail Light)

DESCRIPTION

- Unique patented "GLO" design, halo effect on running, all LED lit on stop
- Polycarbonate lens sonically sealed to housing to prevent moisture intrusion
- Electronics completely sealed in epoxy to resist corrosion and moisture
- Easy wiring with 4 hardwired wire leads
- Universal stud mount LED combination GLOLight with 30 red LED (Stop/Turn/Tail) + 6 white LED (backup) + 3 white LED (license)

Item #	Drive/Passenger	Function	Pack
36909	Driver	S/T/T+Backup	Card
36910	Passenger	S/T/T	Card

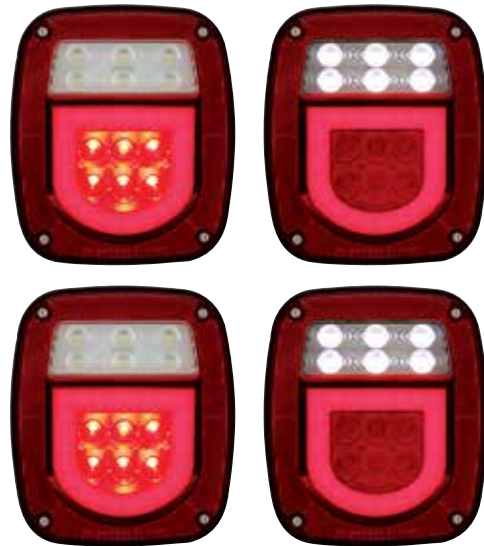

19 LED (Stop, Turn, Tail) Light - STUD Mount

DESCRIPTION

- 19 LED 4" Stud Mount S/T/T Light
- Stud Mount, Black Housing, Studs are Approximately 2" Apart
- Available with or without License Illuminator
- Ground Through Mounting Hardware, **Lifetime Warranty**

Item #	LEDs	License Light	Pack	Carton
38473B	19 Red	No	1 Pc.	Bulk
38474B	19 Red, 5 White	Yes	1 Pc.	Bulk



7 LED (Turn Signal) Light For 2008-2017 Freightliner Cascadia - Dome Lens

DESCRIPTION

- Polycarbonate lens sonically sealed to housing to prevent moisture intrusion
- Fully sealed electronics, works on all 12V DC systems
- Easy plug-in design with OEM style plug
- Replacement for OE #A06-58770-000
- DOT/SAE, FMVSS 108
- IP67 water resistant rating

Item #	LEDs	Lens	Function	Pack
37077	7 Amber	Amber	Dome Lens	Card
37078	7 Amber	Clear	Dome Lens	Card



35 LED 6" Oval Sequential (Turn Signal) Light Amber LED/Amber Lens

DESCRIPTION

- Amber LED sequential flashing arrows
- Electronics completely sealed in epoxy to resist corrosion and moisture
- Polycarbonate lens sonically sealed to housing to prevent moisture intrusion
- 12V DC, rear plastic housing with 3-pin female contact terminal
- Recommend use with 3-pin male plug, item #34212, 34216 (not included)
- Recommend mount with rubber push-in grommet, item #31506 (not included).
- DOT/SAE, FMVSS108, IP67 water resistant.

Item #	LEDs	Lens	Pack	Carton
38143B	35 Amber	Amber	1 Pc.	Bulk
38143BAK	35 Amber	Amber	1 Kit	Bulk

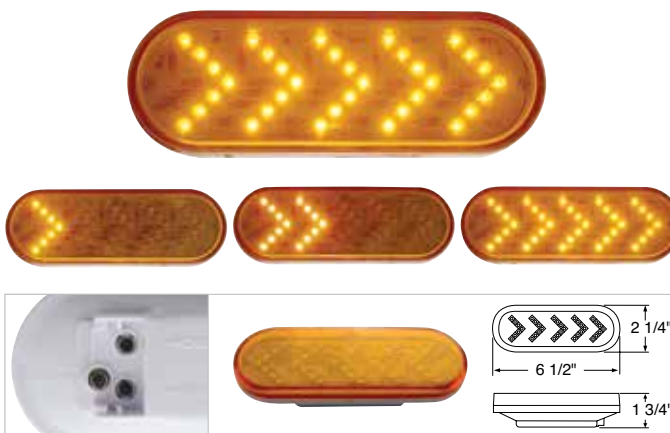

Multi Purpose 5 Switch Control Panel

DESCRIPTION

- Multi purpose 5 switch control panel for United Pacific directional/warning light bar
- Allow user to select desired warning and flash pattern
- Click here to download the instruction sheet

Item #	Description	Pack
40086	5 Switch Control Panel	Card



Traffic Arrow Switch With LED Indicators

DESCRIPTION

- Traffic arrow switch for United Pacific directional/warning light bar
- Allow user to select desired warning pattern and flash direction
- With LED indicators

Item #	Description	Pack
40089	Traffic Arrow Switch	Card





13 LED 4" Round Abyss Light (Back-Up) White LED/Clear Lens

DESCRIPTION

- Abyss lens design gives unique infinity vision effect
- Polycarbonate lens sonically sealed to housing to prevent moisture intrusion
- Electronics completely sealed in epoxy inside a corrosion and impact resistant housing
- Durable plastic housing with 3 contact female plug
- Works with any 12V DC system
- Uses 3-pin electrical connector plug, item #34212/34216
- Mounts with standard 4" round rubber push-in grommet, item #31515
- DOT/SAE, FMVSS 108. Lifetime warranty

Item #	LED	Lens	Pack	Card
36568	White	Clear	1 Pc.	Card



6 LED 4" (Back-Up) Light

DESCRIPTION

- Polycarbonate lens sonically sealed to housing to prevent moisture intrusion
- Electronics completely sealed in epoxy to resist corrosion and moisture
- Bright LEDs, works on all 12V DC system
- Rear plastic housing with 3-pin female contact terminal
- Recommends use with 3-pin male connector plug, item #34212, 34216 (not included)
- Recommends mounting with 4" rubber push-in grommet, item #31515 (not included)
- DOT/SAE, FMVSS 108, IP67 water resistant rating

Item #	LEDs	Lens	Function	Pack
38660	6 White	Clear	Backup	Card

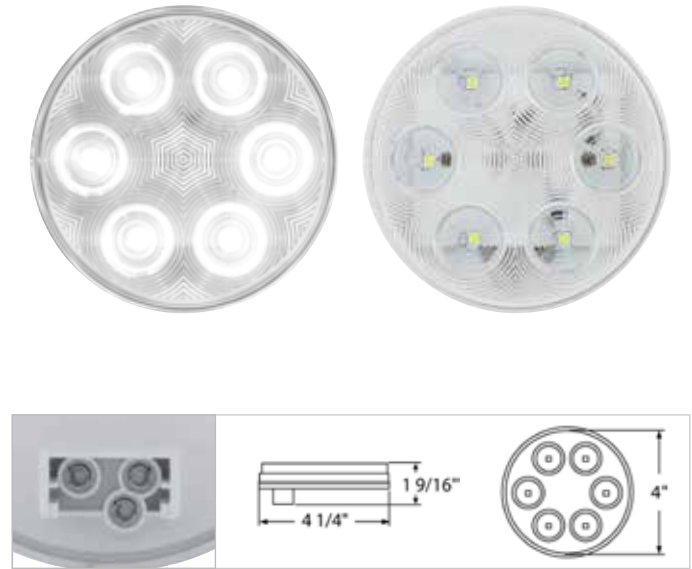

21 LED 4" GloLight (Back-Up)

DESCRIPTION

- Polycarbonate lens sonically sealed to housing to prevent moisture intrusion
- Bright LEDs with vivid glow effect, patented GloLight design US9,062,845B1
- Fully sealed electronics, works on all 12V DC system
- Rear plastic housing with 3-pin female contact terminal
- Recommend use with 3-pin male plug, item #34212, 34216 (not included)
- Recommend mount with rubber push-in grommet, item #31515 (not included)
- DOT/SAE, FMVSS 108, IP67 water resistant rating

Item #	LEDs	Lens	Function	Pack
37008	21 White	Clear	Back-Up	Card
37008B	21 White	Clear	1 Pc.	Bulk
37008BCK	21 White	Clear	1 Kit	Bulk

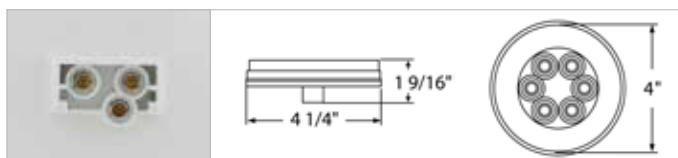



22 LED 6" Oval Abyss Light (Back-Up)

DESCRIPTION

- Polycarbonate lens sonically sealed to housing to prevent moisture intrusion
- Epoxy coated, fully sealed electronics designed for 12V DC systems
- Abyss lens design gives unique infinity vision effect
- Corrosion and impact resistant plastic housing with 3 contact female plug
- Recommend use with 3-pin electrical plug, item #34212, 34216
- Recommend mount with standard 6" oval rubber grommet, item #31506
- DOT/SAE, FMVSS 108

Item #	LED	Lens	Pack	Card
36573	White	Clear	1 Pc.	Card



20 LED 6" Oval Back-Up Light - Competition Series

DESCRIPTION

- 6" Oval back-up light with 20 super white led
- Polycarbonate lens sonically sealed to housing to prevent moisture intrusion
- Epoxy sealed, specially designed lens, 3 contact female terminal
- Recommended plug: item # 34211/34215

Item #	LED	Lens	Pack	Card
36679	20 White	Clear	1 Pc.	Card
36679B	20 White	Clear	1 Pc.	Bulk
36679BCK	20 White	Clear	1 Kit	Bulk

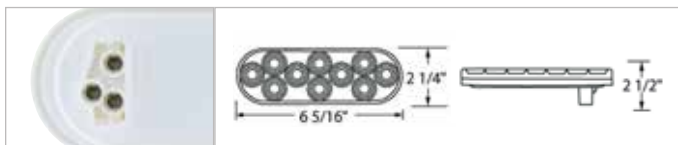

LED BACK-UP, LICENSE & AUXILIARY LIGHTS

20 LED 4" (Back-Up) - Competition Series Light

DESCRIPTION

- 4" Back-Up Light with 20 Super White LED
- Epoxy Sealed, Specially Designed Lens, 3 Contact Female Terminal
- Recommended Plug: Item # 34212/34216, **Lifetime Warranty**

Item #	LEDs	Lens	Pack	Carton
36680B	20 White	Clear	1 Pc.	Bulk
36680BCK	20 White	Clear	1 Kit	Bulk



22 LED 6" Oval GloLight (Back-Up)

DESCRIPTION

- Polycarbonate lens sonically sealed to housing to prevent moisture intrusion
- Electronics completely sealed in epoxy to resist corrosion and moisture
- Bright white LEDs with quality lens, work on all 12V DC system
- Electronics completely sealed in epoxy to resist corrosion and moisture
- Rear plastic housing with 3-pin female contact terminal
- Unique patented GloLight design US9,062,845B1
- DOT/SAE, FMVSS 108, IP67 water resistant rating
- Recommend use with 3-pin male plug, item #34212, 34216 (not included)
- Recommend mount with rubber push-in grommet, item #31506 (not included)

Item #	LEDs	Lens	Function	Pack
37009	22 White	Clear	Back-Up	Card
37009B	22 White	Clear	1 Pc.	Bulk
37009BCK	22 White	Clear	1 Kit	Bulk

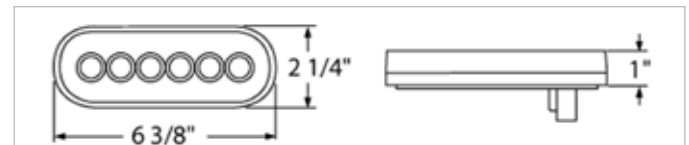

LED BACK-UP, LICENSE & AUXILIARY LIGHTS

13 LED 2 1/2" (Auxiliary/Utility) Light

DESCRIPTION

- 13 LED 2 1/2" auxiliary/utility light
- White LED w/clear lens
- Available with 2 female terminals
- Recommended plug: item # (34210)

Item #	LEDs	Lens	Pack	Carton
38031B	13 White	Clear	1 Pc.	Bulk

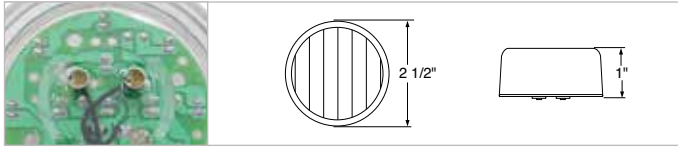

10 LED 4" White (Auxiliary/Utility) Light

DESCRIPTION

- Quality polycarbonate lens with 10 bright LEDs
- Epoxy coated, fully sealed electronics
- Solid state circuit board design for 12V DC system
- Hardwired with 2-pin female bullet plug
- Recommend use with 2-pin male plug, item #34211 (not included)
- Recommend mount with rubber push-in grommet, item #31515 (not included)
- DOT/SAE, FMVSS 108, IP67 water resistant rating.

Item #	LEDs	Lens	Pack	Carton
38828B	10 White	Clear	1 Pc.	Bulk
38828BCK	10 White	Clear	1 Kit	Bulk



12 LED Rectangular (Auxiliary/Utility) Light

DESCRIPTION

- Polycarbonate lens epoxy sealed to rear cover to prevent moisture intrusion
- Solid state circuit board design for 12V DC system
- Recommended mounting base: item #30919, 33006
- DOT/SAE P2, FMVSS 108

Item #	LEDs	Lens	Pack	Carton
39931B	12 White	Clear	1 Pc.	Bulk



32 LED Rectangular (Back-Up) Light

DESCRIPTION

- 32 super bright white LED back-up light
- Available with clear lens
- Epoxy sealed, specially designed lens
- 3 contact female terminal
- Recommended plug: item # (34211/34215)

Item #	LEDs	Lens	Pack	Carton
39998B	32 White	Clear	1 Pc.	Bulk
39998BCK	32 White	Clear	1 Kit	Bulk

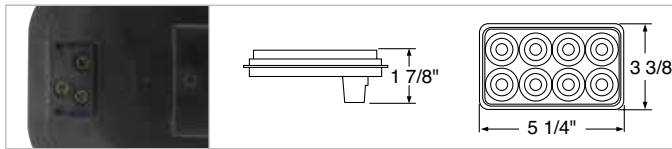

15 LED Rectangular (Back-Up) Light

DESCRIPTION

- Polycarbonate lens sonically sealed to housing to prevent moisture intrusion
- Fully epoxy sealed electronics to resist corrosion and moisture
- Bright LEDs with quality lens, works on all 12V DC system
- Rear plastic housing with 3-pin female contact terminal
- Recommend mount with rubber push-in grommet, item #31516 (not included)
- Recommend use with 3-pin male plug, item #34212, 34216 (not included)

Item #	LEDs	License Light	Pack	Carton
38778B	15 White	Clear	1 Pc.	Bulk
38778BCK	15 White	Clear	1 Kit	Bulk



20 LED 7" Round (Back-Up) Light

DESCRIPTION

- 7" Back-Up Light with 20 Super White LED
- Epoxy Sealed, Specially Designed Lens
- Specially Designed Lens, **Lifetime Warranty**

Item #	LEDs	Lens	Pack	Carton
38395B	20 White	Clear	1 Pc.	Bulk



2 White LED Chrome (License Plate Light/Utility Light) Competition Series

DESCRIPTION

- Super bright white LED utility/license light, 12 volt
- Chrome housing, water resistant
- Mounting pad and screws included

Item #	LEDs	Lens	Function	Pack
39909	2 White	Clear	License/Utility	Card



LED BACK-UP, LICENSE & AUXILIARY LIGHTS

4 White LED Chrome (License Plate Light/Utility Light)

DESCRIPTION

- High quality polycarbonate lens with epoxy sealed circuit board
- Beautiful chrome plated housing
- Mounting pad and screws included
- Mounting holes are 2-1/16" apart
- 12VDC, hard wired with 2 wires
- SAE/DOT, FMVSS 108, IP67 water resistant

Item #	LEDs	Lens	Pack	Carton
39930B	4 White	Clear	1 Pc.	Bulk



2 LED (License Light)

DESCRIPTION

- Bright white LEDs with steel top cover and mounting base plate
- Easy wiring with 2 hardwired wire leads

Item #	LEDs	Lens	Pack	Carton
39994B	2 White	Clear	1 Pc.	Bulk



4 LED Round (License Light)

DESCRIPTION

- Bright white LEDs with steel housing
- Steel retaining tabs for easy push-on installation
- Easy wiring with 2 hardwired wire leads
- Measures roughly 1-1/2" in diameter
- 12V DC compatible

Item #	LEDs	Description	Pack	Carton
39995B	4 LED	Round License Light	1 Pc.	Bulk

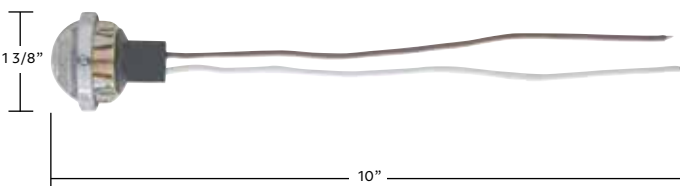

9 LED 2" (Auxiliary/Utility Light)

DESCRIPTION

- 9 super bright LED 2" auxiliary/utility light
- White LED w/clear lens
- Available with 2 female terminals
- Recommended plug: item # 34210

Item #	LEDs	Lens	Pack	Carton
38030B	9 White	Clear	1 Pc.	Bulk



6 High Power LED Super Thin (Warning Light)

DESCRIPTION

- 6 high power LED super thin warning light, only 1/4" tall
- 12-24V DC application, 23 flash pattern
- 3 wire hardwired
- Surface mount, mounting holes are 4 3/4" apart
- Approximate size: 5 1/8" I X 1 3/16" W x 1/4" H

Item #	LEDs	Lens	Function	Pack
36683B	6 Amber	Clear	Warning Light	Bulk
36684B	6 White	Clear	Warning Light	Bulk



6 High Power LED Low Profile (Warning Lighthouse)

DESCRIPTION

- 6 high power white LED warning lighthouse
- Super low profile, only 5/8" tall
- 12-24V DC application, surface mount, 15 flash pattern multiple light synchronization, mounting holes are 4-11/16" apart

Item #	LEDs	Lens	Function	Pack
36690	6 White	Clear	Warning Light	Bulk



12 High Power LED Low Profile (Warning Lighthouse)

DESCRIPTION

- Super low profile, only 5/8" tall
- 12-24V DC application, surface mount, 15 flash pattern multiple light synchronization, mounting holes are 4 11/16" apart
- 12 high power amber LED warning lighthouse

Item #	LEDs	Lens	Function	Pack
36691	12 Amber	Clear	Warning Light	Bulk
36694	12 White	Clear	Warning Light	Bulk



3 High Power LED Super Thin (Warning Light)

DESCRIPTION

- 3 high power LED super thin directional warning light, only 1/4" tall
- 12-24V DC application, 12 flash pattern, 3 wire hardwired
- Surface mount, mounting holes are 3" apart
- Approximate size: 3 1/2" I X 1 13/16" W x 1/4" H

Item #	LEDs	Lens	Function	Pack
36630B	3 Amber	Amber	Warning Light	Bulk



WARNING LIGHTS

6 High Power LED “Competition Series” Slim (Warning Light)

DESCRIPTION

- Slim profile and surface mounted for easy installation
- Rugged cast aluminum construction resists corrosion and vibration. IP67 rating
- High power LED with 11 flash patterns, selectable for synchronized and alternating
- 12-24V DC applications
- 6 high power LED’s with 11 flash patterns, selectable for synchronized and alternating

Item #	LEDs	Lens	Function	Pack
39161	6 Amber	Clear	Warning Light	CBox
39162	6 Blue	Clear	Warning Light	CBox
39163	6 Green	Clear	Warning Light	CBox
39164	6 Red	Clear	Warning Light	CBox
39165	6 White	Clear	Warning Light	CBox

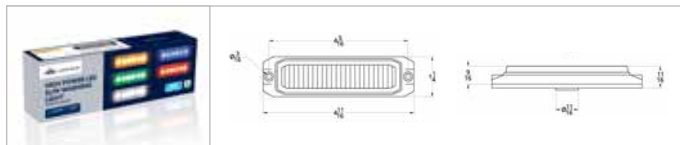
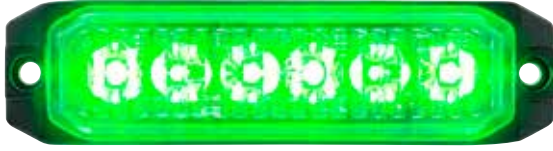
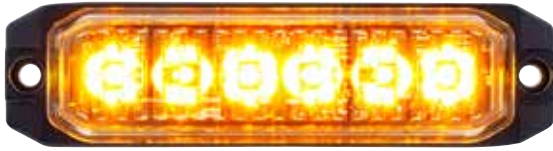

6 High Power LED Super Thin Directional (Warning Light)

DESCRIPTION

- 12-24V DC application, surface mount, 19 flash pattern, multiple light synchronization, mounting holes are 4” apart
- 6 high power LED super thin directional warning light
- Super slim design, install anywhere

Item #	LEDs	Lens	Function	Pack
37042B	6 Amber	Clear	Warning Light	Bulk
37045B	6 White	Clear	Warning Light	Bulk

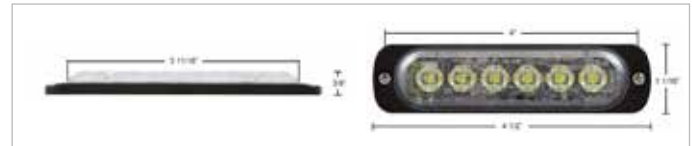

4 High Power LED Square (Warning Lighthouse)

DESCRIPTION

- 4 high power LED square warning lighthouse
- 12-24V DC application, stud mount, 19 flash pattern

Item #	LEDs	Lens	Function	Pack
37186B	4 Amber	Clear	Warning Light	Bulk
37187B	4 Blue	Clear	Warning Light	Bulk
37189B	4 White	Clear	Warning Light	Bulk



6 High Power LED Rectangular (Warning Light) With Bracket

DESCRIPTION

- 6 high power LED warning light with bracket, 0.5w SMD LED
- 12-24V DC application, bracket mount, single flash pattern, IP67 rated

Item #	LEDs	Lens	Function	Pack
37158B	6 Amber	Clear	Warning Light	Bulk
37159B	6 Blue	Clear	Warning Light	Bulk
37160B	6 Red	Clear	Warning Light	Bulk



6 High Power LED Rectangular (Warning Light)

DESCRIPTION

- 12-24V DC application, surface mount, single flash pattern, IP67 rated
- Mounting holes are 4 3/4" apart
- 6 high power blue LED rectangular warning light, 0.5w SMD LED

Item #	LEDs	Lens	Function	Pack
37163B	6 Amber	Clear	Warning Light	Bulk
37164B	6 Red	Clear	Warning Light	Bulk



18 High Power LED 26-1/2" Directional (Warning Light) Bar

DESCRIPTION

- High power LED directional/warning light bar
- Super slim profile, only 7/8" tall X 1 1/2" wide
- 20 warning patterns and 11 arrow patterns
- 4 wire hardwired, heavy duty aluminum housing
- Brackets required for installation, mounting brackets sold separately: item # 36941B surface mount bracket or 36942B I bracket
- SAEJ595 class 13, IPX7 rated

Item #	LEDs	Lens	Function	Pack
36944	18 Amber	Clear	Warning Light	Each



6 LED 1" (Warning Light) - Split Color

DESCRIPTION

- 6 LED 1" warning light, split color
- Amber/white LED on one unit
- 12V DC application, 19 flash pattern, multiple light synchronization, grommet mounts into any 1" opening
- Each box contains two 1" LED mini warning light

Item #	LEDs	Lens	Function	Pack
37000	6 Amber/White	Clear	Warning Light	Each



WARNING LIGHTS

4 LED (Warning Light)

DESCRIPTION

- 4 high power LED warning light with deluxe chrome bezel
- 12-24V DC application, surface mount, 12 flash pattern, multiple light synchronization
- Mounting holes are 4-1/8" apart

Item #	LEDs	Lens	Function	Pack
37233	4 Amber	Clear	Warning Light	CBox
37235	4 Red	Clear	Warning Light	CBox
37236	4 White	Clear	Warning Light	CBox
37237	4 Amber/White	Clear	Warning Light	CBox



4 High Power LED Dash (Warning Light)

DESCRIPTION

- 4 high power LED dash warning light
- 12-24V DC applications, 19 flash pattern
- Windshield mount, cigarette adapter

Item #	LEDs	Lens	Function	Pack
37182B	4 Amber	Clear	Warning Light	Bulk
37184B	4 Red	Clear	Warning Light	Bulk



30 High Power LED Micro (Warning Light)Bar Magnet Mount

DESCRIPTION

- 30 high power LED micro warning light bar
- 12-24V DC application, 22 flash pattern
- SAE J845 class 1 & class 2 rated
- Available in magnet mount

Item #	LEDs	Lens	Function	Pack
36921	30	Clear	Warning Light	Each



6 High Power LED Super Thin Directional (Warning Light)

DESCRIPTION

- 12-24V DC application, surface mount, 19 flash pattern, multiple light synchronization, mounting holes are 4" apart
- 6 high power LED super thin, dual color, directional warning light, only 3/8" tall
- Available in amber & white led
- Approximate size: 4 7/16" L x 1 1/8" W x 3/8" H

Item #	LEDs	Lens	Function	Pack
36926B	6 Amber & White	Clear	Warning Light	Each



3 LED (Warning Light) With Chrome Bezel

DESCRIPTION

- 3 high power LED warning light with chrome bezel
- Mounting holes are 3-1/4" apart
- 12-24V DC application, surface mount, 12 flash pattern, multiple light synchronization
- Available in amber LED
- 12-24V DC application, surface mount, 12 flash pattern, multiple light synchronization

Item #	LEDs	Lens	Function	Pack
37538B	3 Amber	Clear	Warning Light	Bulk
37541B	3 White	Clear	Warning Light	Bulk



3 LED Mini (Warning Light)

DESCRIPTION

- Mini 3 high power LED warning light, low profile
- 12-24V DC application, surface mount, 12 flash pattern, multiple light synchronization
- Mounting holes are 3 1/16" apart
- Available in amber LED

Item #	LEDs	Lens	Function	Pack
37542B	3 Amber	Clear	Warning Light	Bulk
37544B	3 Red	Clear	Warning Light	Bulk



3 LED (Warning Light) With Black Bezel

DESCRIPTION

- 3 high power LED warning light with black bezel
- 12-24V DC application, surface mount, 12 flash pattern, multiple light synchronization
- Mounting holes are 3 1/4" apart

Item #	LEDs	Lens	Function	Pack
37537B	3 White	Clear	Warning Light	Bulk



3 High Power LED (Warning Light) - Amber LED

DESCRIPTION

- 3 high power LED warning light with deluxe chrome bezel
- Multiple light synchronization
- 12-24V DC application, surface mount, 12 flash pattern
- Mounting holes are 4-1/8" apart

Item #	LEDs	Lens	Function	Pack
37627	3 Amber	Clear	Warning Light	Each



3 LED 1" Dual Function (Auxiliary/Utility) Light With Visor

DESCRIPTION

- Feature 3 high power LEDs with quality lens
- Beautiful chrome bezel with visor

Item #	LEDs	Lens	Function	Pack
36899	3 Amber	Amber	Warning Light	Card
36901	3 Amber	Clear	Warning Light	Card





24 LED Dual Function 12” GloLight Bar

DESCRIPTION

- Unique patented GloLight design, vivid glow effect
- Polycarbonate lens sonically sealed to housing to prevent moisture intrusion
- Electronics completely sealed in epoxy to resist corrosion and moisture
- Approximate size: 12” L X 5/8” W, mounting holes approximately 11-7/16” apart
- Lifetime warranty
- Bright amber LEDs with quality amber lens, work on all 12V DC system
- Available in retail packaging

Item #	LEDs	Lens	Function	Pack
36861	24 Amber	Amber	Turn Signal	Card
36861B	24 Amber	Amber	Turn Signal	Bulk
36862	24 Red	Red	Stop/Turn/Tail	Card
36862B	24 Red	Red	Stop/Turn/Tail	Bulk
36863	24 Amber	Clear	Turn Signal	Card
36863B	24 Amber	Clear	Turn Signal	Bulk
36864	24 Red	Clear	Stop/Turn/Tail	Card
36864B	24 Red	Clear	Stop/Turn/Tail	Bulk

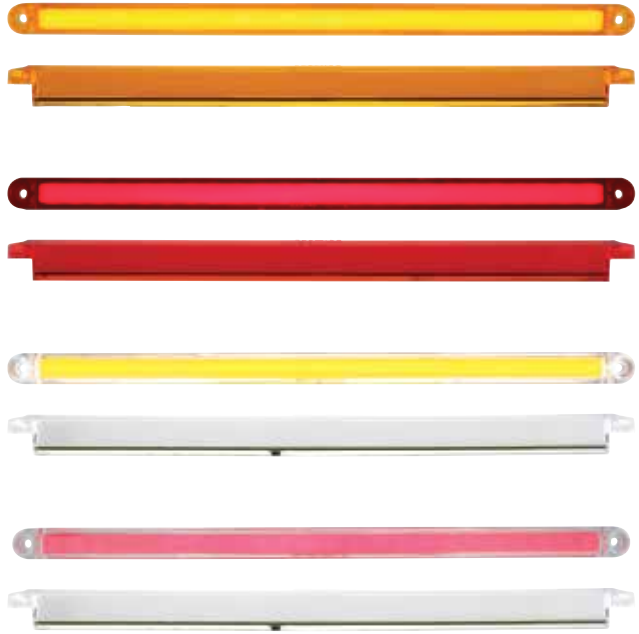

28 LED 17” GloLight Bar (Turn Signal) or Stop/Turn/Tail

DESCRIPTION

- 28 LED P/T/C or stop, turn & tail “GLO” light bar
- Polycarbonate lens sonically sealed to housing to prevent moisture intrusion
- Electronics completely sealed in epoxy to resist corrosion and moisture
- Unique patent pending “GLO” design
- Glow effect on running, all LED lit on stop
- Mounting holes approximately 16 1/8” apart

Item #	LEDs	Lens	Function	Pack
37079	28 Amber	Amber	Turn Signal	Card
37080	28 Red	Red	Stop/Turn/Tail	Bulk
37081	28 Amber	Clear	Turn Signal	Card
37082	28 Red	Clear	Stop/Turn/Tail	Bulk



23 SMD LED 17-2/4” Reflector S/T/T & Turn Signal Light Bars

DESCRIPTION

- Features long lasting, bright SMD LEDs
- Polycarbonate lens sonically sealed to housing to prevent moisture intrusion
- Electronics completely sealed in epoxy to resist corrosion and moisture
- Mounting holes approximately 16-1/8” apart
- Shipped in retail packaging

Item #	LEDs	Lens	Function	Pack
37089	23 Amber	Amber	Turn Signal	Card
37090	23 Red	Red	Stop/Turn/Tail	Card
37091	23 Amber	Clear	Turn Signal	Card
37091B	23 Amber	Clear	Turn Signal	Bulk
37092	23 Red	Clear	Stop/Turn/Tail	Card
37092B	23 Red	Clear	Stop/Turn/Tail	Bulk

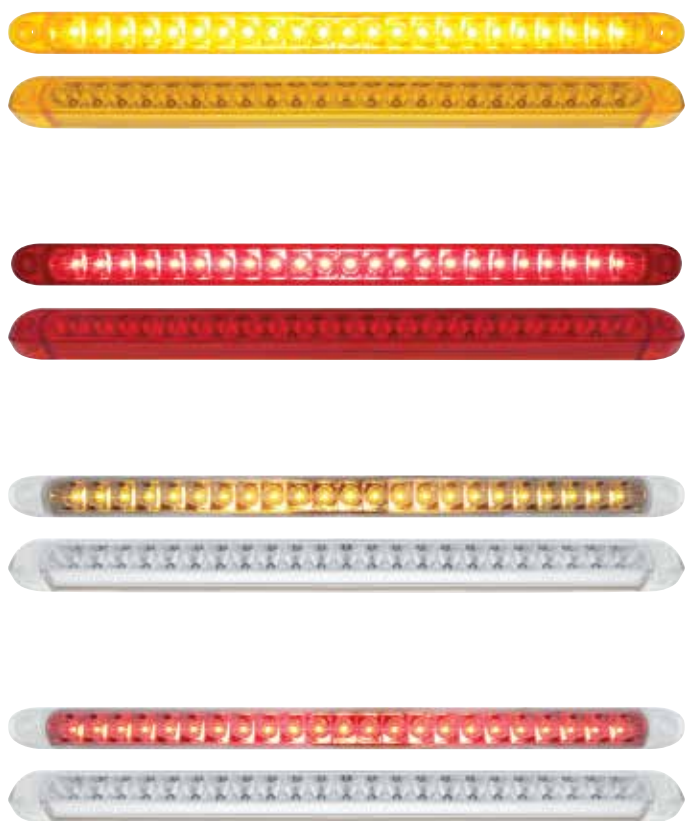

23 LED 17-1/4” Reflector S/T/T & Turn Signal Light Bar With Bezel

DESCRIPTION

- 23 LED 17 1/4” light bar with chrome plastic bezel
- Polycarbonate lens sonically sealed to housing to prevent moisture intrusion
- Amber LED w/amber lens item # 37089b
- Chrome light bar bezel available separately: item # 34059b

Item #	LEDs	Lens	Function	Pack
37510	23 Amber	Amber	Turn Signal	Card
37511	23 Red	Red	Stop/Turn/Tail	Card
37512	23 Amber	Clear	Turn Signal	Card
37513	23 Red	Clear	Stop/Turn/Tail	Bulk

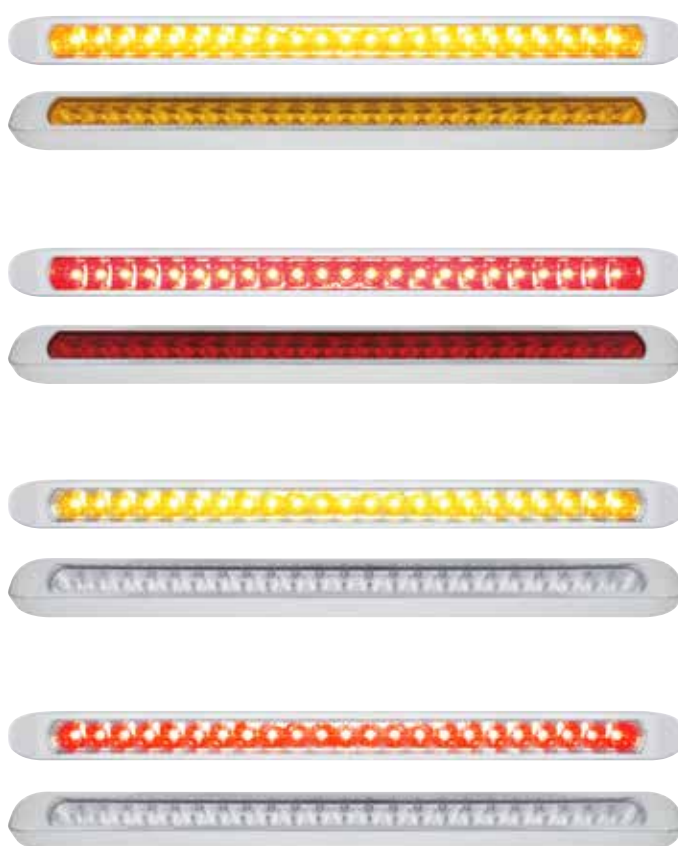

10 LED 9” Dual Function Light Bar - White LED/Clear Lens

DESCRIPTION

- 10 LED 9” auxiliary light bar, 3 wire hardwired.
- Mounting holes approximately 8-1/2” apart, lifetime warranty.

Item #	LEDs	Lens	Function	Pack
38005	10 White	Clear	Dual Function	Card
38005B	10 White	Clear	Dual Function	Bulk



LED LIGHT BARS

19 LED 12" Reflector Turn Signal Light Bar

DESCRIPTION

- High quality injection molded polycarbonate lens
- Epoxy coated, fully sealed electronics
- Energy efficient solid-state circuit board engineered for 12V DC systems
- Feature 19 bright amber LEDs
- Easy wiring with 3 hardwired wire leads
- Mounting holes approximately 11-7/16" apart

Item #	LEDs	Lens	Function	Pack
39773	19 Amber	Amber	Turn Signal	Card
39774	19 Red	Red	Stop/Turn/Tail	Card
39775	19 Amber	Clear	Turn Signal	Card
39776	19 Red	Clear	Stop/Turn/Tail	Card

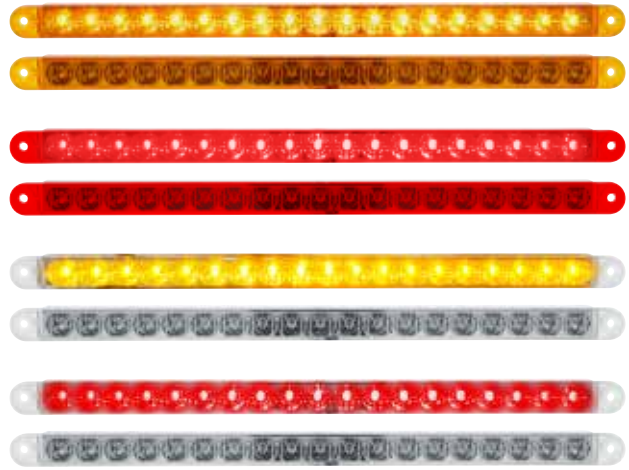

14 LED 12" Auxiliary Warning Light Bar

DESCRIPTION

- Bright LED with warning light function
- 6 flash pattern, multiple light synchronization
- Mounting screws can be moved to accommodate mounting distance from 4-1/2" to 7-3/8" apart, Stainless steel mounting hardware included
- 12" chrome plastic light bar bezel can be purchase separately, item # 30933b

Item #	LEDs	Lens	Bezel	Pack
37190	19 Amber	Amber	With Bezel	Card
37192B	19 Red	Red	Without Bezel	Card



49" High Power LED Warning Light Bar

DESCRIPTION

- 49" High Power LED Warning Light Bar, 12V - 24V Application, 26 Flash Pattern
- 3 LED Fresnel Optics for Front / Rear Light heads and 6 LED Large D-Fuser for Corner Light heads
- SAE J845, Class 13, IPX 4 Rated
- Available with 8 (4 Inboards) Light heads, 12 (8 Inboards) Light heads, or 16 (12 Inboards) Light heads
- Brackets Required for Installation, Includes Standard Bolt / Strap Mount Bracket

Item #	Length	LEDs	LED Heads	Pack
36669	49"	48	12	1 Pc./Box
36670	49"	60	16	1 Pc./Box

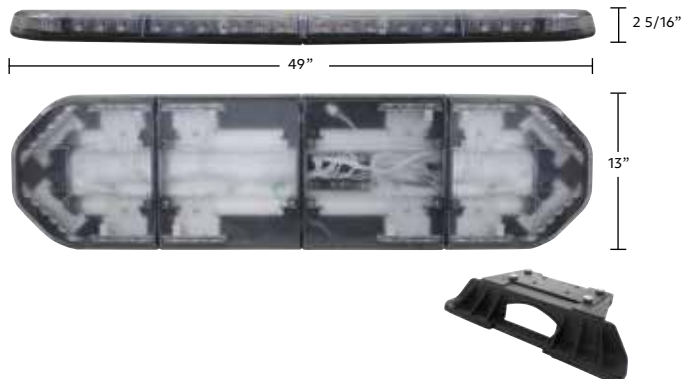

Standard Bolt / Strap Mount



36669 - 12 LED Light heads



36670 - 16 LED Light heads



9 Red LED 17" Light Bar With 4 White LED Back Up Light

DESCRIPTION

- 4 in 1 function LED tail light bar with LED stop/turn/tail and LED backup light
- Hard wired with 4 wires, 12 volt
- Perfect for trailers, or below tailgate on pickups
- Approximate size 17" X 1-5/8" X 1-3/16"
- Surface mount. mounting holes 16-1/8" center to center

Item #	Light Bar	Backup Light	Function	Pack
36499B	9 Red LEDs	4 White LEDs	S/T/T & Backup	Bulk



17" Identification LED Light Bar - Red

DESCRIPTION

- Black polycarbonate bar with LED lights
- Equipped with three 6 LED rectangular clearance/marker light
- Mounting holes 7-7/16" center to center
- Grounds through mounting screw
- Pre-wired light bar for easy installation

Item #	LEDs	Marker Lights	Pack	Pack
36746	6	3	1 Pc.	Card



23 SMD LED 17 1/4" (Stop, Turn, Tail) & (Tail Light) Bar With Reflector

DESCRIPTION

- 23 SMD LED 17 1/4" S/T/T & P/T/C Light Bar with Reflector
- Available in Red Lens, Approximate Size: 17 1/4" L x 1" W
- Mounting Holes Approximately 16 1/8" Apart, **Lifetime Warranty**

Item #	LEDs	Lens	Pack	Carton
37089B	23 Amber	Amber	1 Pc.	Bulk
37090B	23 Red	Red	1 Pc.	Bulk



11 LED 15" Light Bar

DESCRIPTION

- 11 LED 15" S/T/T & P/T/C Light Bar, Ultra Thin/Low Profile Design
- Available with Colored or Clear Lens, Approximate Size: 15" L x 1 3/8" W
- Mounting Holes Approximate 14 1/8" Apart, **Lifetime Warranty**

Item #	LEDs	Lens	Pack	Carton
39990B	11 Amber	Clear	1 Pc.	Bulk



11 LED 17" Light Bar

DESCRIPTION

- 11 LED S/T/T & P/T/C Light Bar, 17" L x 1 3/8" W x 1" H
- Available in Colored or Clear Lens, Mounting Holes Approximately 16 1/8" Apart

Item #	LEDs	Function	Lens	Pack	Carton
38463B	11 Amber	P/T/C	Amber	1 Pc.	Bulk
38469B	11 Red	S/T/T	Red	1 Pc.	Bulk



LED WORK LIGHTS

4.5" 24 High Power LED Work Light With "X" Light Guide

DESCRIPTION

- High power spot & flood beam combination work light with unique 15 LED "X" light guide position light
- Water resistant die cast aluminum housing with polycarbonate lens provides maximum protection & durability
- Includes stainless steel mounting bracket
- Solid state design resists shock and vibration
- 5200 lumens, IP67 water resistant, 12-24V DC

Item #	LEDs	Lens	Pack	Box
36454	24 Amber	Clear	1 Pc.	CBox
36455	24 Blue	Clear	1 Pc.	CBox
36456	24 Red	Clear	1 Pc.	CBox
36457	24 White	Clear	1 Pc.	CBox



5 LED Mini Work Light

DESCRIPTION

- Bright 1000 lumens output and 6200K color temperature
- IP68 waterproof with die-cast housing and sealed polycarbonate lens provide maximum protection & durability
- Solid state design resists shock and vibration
- Flood or spot light function with wide beam output

Item #	LEDs	Function	Pack	Box
36461	5 White	Flood	1 Pc.	CBox
36462	5 White	Flood	1 Pc.	CBox
36463	5 White	Spot	1 Pc.	CBox
36464	5 White	Spot	1 Pc.	CBox



High Power Single LED Mini Work Light

DESCRIPTION

- High power LED with single 10W CREE LED with spot function
- 1,000 lumens. Operates on 12-24V DC, draws 0.5 amps at 12V
- Solids & Liquid Protection Rating: IP-67

Item #	LEDs	Lens	Pack	Box
36506	25 White	Clear	1 Pc.	Box



8 High Power LED Rectangular Work Light With Chrome Reflector

DESCRIPTION

- Heavy duty die cast aluminum housing, 1,200 lumens
- Stainless steel mounting bracket with hardware included
- Operates on 12-24V DC, draws 1.66 amps at 12V
- 3 year warranty

Item #	LEDs	Lens	Pack	Box
36507	8 White	Clear	1 Pc.	Box



8 LED Oval Wide Angle Driving/Work Light Reflector

DESCRIPTION

- 8 LED oval light, wide angle design
- 12-36V DC application, 1920 lumens
- Shipped in retail ready packaging

Item #	LEDs	Lens	Pack	Box
36515	8 White	Clear	1 Pc.	Box
36515B	8 White	Clear	1 Pc.	Bulk

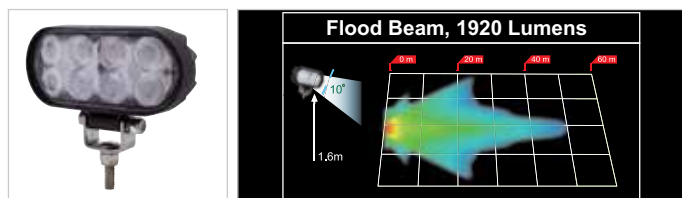

17 High Power LED 7" Spot/Off Road Light

DESCRIPTION

- New and improved 2022 version with slimmer heat sink
- Quality acrylic glass lens with diecast aluminum housing
- 12-24V DC, 3100 lumens, 34W total power
- Solids & liquid protection rating: IP-67
- 3 year warranty

Item #	LEDs	Lumens	Voltage	Pack
36516	17 White	3100	12-24V	Box



LED WORK LIGHTS

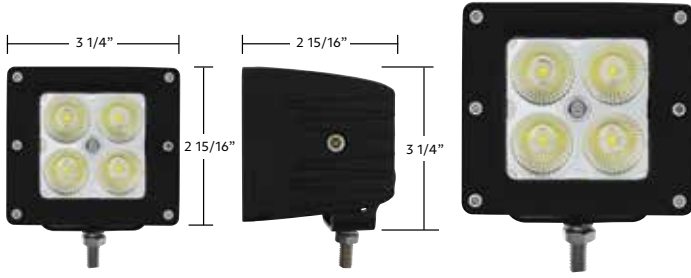

36533

4 High Power LED Work Lights - Flood or Spot Light

DESCRIPTION

- Four 3W high power LED with a total rated output of 1400 lumens
- Die-cast aluminum housing, polycarbonate lens
- 12-24V DC compatible, 50,000 hours of LED life
- Integrated thermal management
- Bracket mount, mounting screw included
- Solids & liquid protection rating: IP-68.8

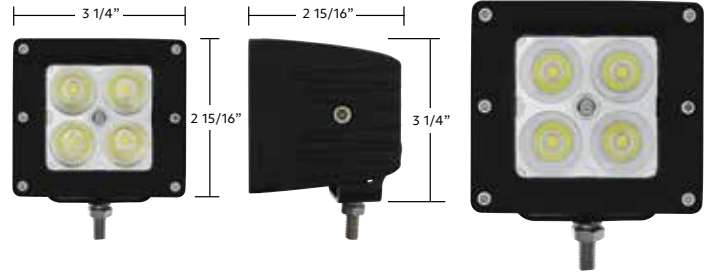

36534

Item #	LEDs	Lumens	Function	Voltage	IP Rating	Pack
36533	4 White	1400	Flood	12V - 24V	IP68.8	CBox
36534	4 White	1400	Spot	12V - 24V	IP68.8	CBox

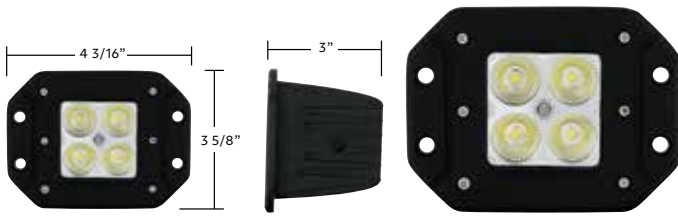

36535

4 High Power LED Work Lights - Flood or Spot Light

DESCRIPTION

- Four 3W high power LED with a total rated output of 1400 lumens
- Die-cast aluminum housing, polycarbonate lens
- 12-24V DC compatible, 50,000 hours of LED life
- Integrated thermal management
- Bracket mount, mounting screw included
- Solids & liquid protection rating: IP-68

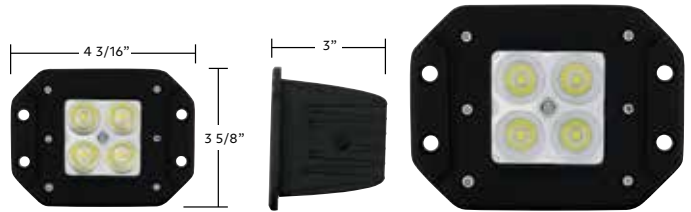

36536

Item #	LEDs	Lumens	Function	Voltage	IP Rating	Pack
36535	4 White	1400	Flood	12V - 24V	IP68.8	CBox
36536	4 White	1400	Spot	12V - 24V	IP68.8	CBox

9 High Power LED 4-1/2" Round "Competition Series" Work Light - Spot

DESCRIPTION

- Super bright 1400 lumen LED with 6000K color temperature
- Features cast aluminum housing and quality polycarbonate lens
- Includes mounting bracket and hardware
- 12-24V DC applications
- IP-67 Dust & Liquid Protection Rating
- Spot light or flood light function with concentrated beam output



Item #	LEDs	Lumens	Function	Voltage	IP Rating	Pack
36617	9 White	1400	Spot	12V - 24V	IP67	Box



9 High Power LED 4-1/4" Square "Competition Series" Work Light - Flood

DESCRIPTION

- Super bright 1400 lumen LED with 6000K color temperature
- Features cast aluminum housing and quality polycarbonate lens
- Includes mounting bracket and hardware
- 12-24V DC applications
- IP-67 Dust & Liquid Protection Rating
- Spot light or flood light function with concentrated beam output

Item #	LEDs	Lumens	Function	Voltage	IP Rating	Pack
36618	9 White	1400	Flood	12V - 24V	IP67	Box



9 High Power LED Round Work Light - Spot

DESCRIPTION

- High Power 1700 lumen LED work Light, competition Series
- Flood light function with wide beam output
- Features cast aluminum housing and quality polycarbonate lens
- Includes mounting bracket and hardware
- 12-24V DC applications
- IP-67 Dust & Liquid Protection Rating

Item #	LEDs	Lumens	Function	Voltage	IP Rating	Pack
36671	3 Watt x 9	1700	Flood	12V - 30V	IP68	1 Pc./Card



9 High Power 3-Watt LED Work Light - Slim Profile

DESCRIPTION

- High power LED light with 3 watt LED's
- 1,800 lumens. Operates on 12V DC

Item #	LEDs	Lumens	Function	Voltage	IP Rating	Pack
36965	3 Watt x 9	1800	Flood	10V-16V	IP67	1 Pc./Card

4 High Power 3-Watt LED Round Compact Work Light - Flood

DESCRIPTION

- Compact 3-1/2" diameter work light
- Bright flood pattern with 4 high power LEDs
- Easy installation with single stud mounting
- 12-24V DC, 3 watts, 1000 lumens
- IP67 water resistant rating



Item #	LEDs	Lumens	Function	Voltage	IP Rating	Pack
37087	3 Watt x 4	1000	Flood	12V - 24V	IP67	1 Pc./Card

3 High Power LED Round Compact Work Light

DESCRIPTION

- 3 high power 3 watt LED round work light.
- 12-24V DC application, 600 lumens.
- Compact design only measures 3-3/8" X 5-3/8" X 2-1/4".



Item #	LEDs	Lumens	Function	Voltage	IP Rating	Pack
37074	3 Watt x 3	600	Flood	9V - 32V	IP67	1 Pc./Card

6 LED High Power 18 Watt Round Work Light

DESCRIPTION

- Feature 6 bright 3 watt SMD type LEDs
- Durable aluminum housing with visor bezel
- 12-24V DC application, 600 lumens, IP67 rating
- Includes 5/16" mounting stud, matching hardware and bracket allows mounting in any position



Item #	LEDs	Lumens	Function	Voltage	IP Rating	Pack
39688	1 Watt x 6	600	Flood	12V-24V	IP67	1 Pc./Card
39688B	1 Watt x 6	600	Flood	12V-24V	IP67	Bulk



6 High Power 1 Watt LED 4" Round Spot/Utility Light

DESCRIPTION

- High power white LEDs with rated output at 480 lumens
- Easy wiring with two 9" long lead wires
- Includes stainless steel bracket and mounting hardware. 3/8" mounting hole required
- Fits any 12V DC applications
- Warning: high power LED emits a large amount of heat. Please handle the light with care after operating the light for an extended period

Item #	LEDs	Lumens	Function	Voltage	IP Rating	Pack
39979	1 Watt x 6	480	Spot	12V	IP65	1 Pc./Card



6 High Power Rectangular 5 Watt LED Work Light

DESCRIPTION

- 6 high power, extra bright 5 watt LED rectangular light
- 12-24V DC application
- 1700 lumens
- Universal Swivel Mounting Bracket
- Warning: high power LED emits a large amount of heat
- Please handle the light with care after operating the light for an extended period

Item #	LEDs	Lumens	Function	Voltage	IP Rating	Pack
37563	5 Watt x 6	1700	Flood	12V - 24V	IP67	1 Pc./Card



6 High Power Rectangular 3-Watt SMD LED Rectangular Flood Light

DESCRIPTION

- 6 high power 3 watt SMD LED rectangular flood light
- Heavy duty die-cast housing
- Stainless steel mounting hardware
- 12-36V DC application
- 1440 lumens

Item #	LEDs	Lumens	Function	Voltage	IP Rating	Pack
37123	2.5 Watt x 6	1440	Flood	12V - 36V	IP67	1 Pc./Card

6 High Power 1 Watt LED Rectangular Work Light

DESCRIPTION

- 6 high power LEDs with combined output of 500 lumens
- 12V DC application, with 2-wire wiring leads
- Universal mounting design with 7/8" long stud and hardware allows mounting in any position
- Warning: high power LED emits large amount of heat, please handle with care after operating for an extended period
- IP67 water resistant rating



Item #	LEDs	Lumens	Function	Voltage	IP Rating	Pack
39901	1 Watt x 6	500	Flood	12V - 24V	IP67	1 Pc./Card
39901B	1 Watt x 6	500	Flood	12V - 24V	IP67	Bulk

9 High Power LED Square Work Light - Flood

DESCRIPTION

- High Power 1700 lumen LED work Light, competition Series
- Flood light function with wide beam output
- Features cast aluminum housing and quality polycarbonate lens
- Includes mounting bracket and hardware
- 12-24V DC applications
- IP-67 Dust & Liquid Protection Rating



Item #	LEDs	Lumens	Function	Voltage	IP Rating	Pack
36672	3 Watt x 9	1700	Flood	12V - 30V	IP68	1 Pc./Card

9 High Power LED Square Work Light - Flood Light

DESCRIPTION

- Quality polycarbonate lens with durable aluminum housing
- Bright SMD LEDs with 2160 lumens rating
- 12-36V DC application
- Include stainless steel bracket and hardware
- Easy wiring with 2 wire leads



Item #	LEDs	Lumens	Function	Voltage	IP Rating	Pack
37597	3 Watt x 9	2160	Flood	12V - 36V	IP67	1 Pc./Card

1 High Power 10-Watt LED Square Mini Work Light - 800 Lumens

DESCRIPTION

- 1 high power 10 Watt LED mini light
- Flood function with IP69K rating
- 12-36V DC, 800 lumens



Item #	LEDs	Lumens	Function	Voltage	IP Rating	Pack
37088	10 Watt x 1	800	Flood	12V - 36V	IP67	1 Pc./Card
37088B	10 Watt x 1	800	Flood	12V - 36V	IP67	Bulk

3 High Power 3 Watt LED Square Compact Work Light - Flood Light

DESCRIPTION

- 3 high power 3 Watt LEDs
- 12-36V DC application, 240 lumen per LED, 720 lumens



Item #	LEDs	Lumens	Function	Voltage	IP Rating	Pack
37157	3 Watt x 3	240	Flood	12V - 36V	IP67	1 Pc./Card

4 High Power 3-Watt LED Compact Work Light

DESCRIPTION

- 4 high power 3 watt LED compact light
- 12-36V DC application, 700 lumens
- Compact design only measures 2-13/16" X 4-3/4" X 1-1/8"



Item #	LEDs	Lumens	Function	Voltage	IP Rating	Pack
36854	3 Watt x 4	700	Flood	9V - 32V	IP69K	1 Pc./Card

Item #	LEDs	Lumens	Length	Pack
36763	12	2160 lm	8"	1 Pc./Box



12 High Power LED Dual Row 8" Curved Flood/Spot Light Bar

DESCRIPTION

- 3w high power double row, curved LED light bar
- 12-24V DC applications, solids & liquid protection rating: IP-67
- 3" tall 3-7/8" wide, light is 4-3/4" tall with mounting bracket
- Available in 6 different lengths, heavy duty aluminum housing
- Available 2160 lumens



200 High Power LED Quad Row 51-1/2" Reflector Flood/Spot Light Bar

DESCRIPTION

- High power 1.5W individual LED, reflective inner housing
- Heavy duty aluminum housing
- 200 total LEDs, combined 18000 lumens
- Suitable with 12-24V DC application
- 3-1/4" tall x 2-1/8" wide, light is 5-1/8" tall with mounting bracket

Item #	LEDs	Lumens	Length	Pack
36651	200	18000 lm	51.5"	1 Pc./Box

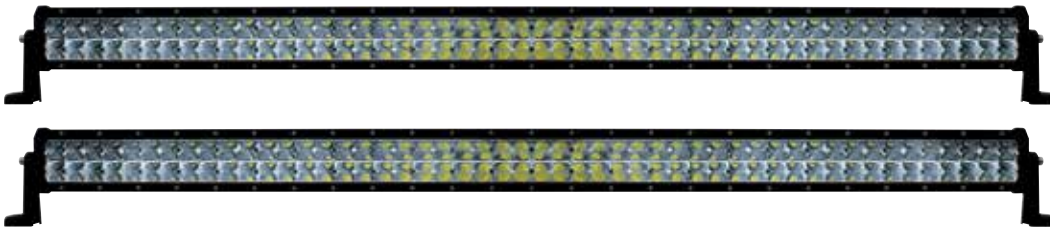

High Power LED Dual Row Flood/Spot Light Bar

DESCRIPTION

- High power 1.5W individual LED, reflective inner housing
- Heavy duty aluminum housing
- 200 total LEDs, combined 18000 lumens
- Suitable with 12-24V DC application
- 3-1/4" tall x 2-1/8" wide, light is 5-1/8" tall with mounting bracket

Item #	LEDs	Lumens	Length	Pack
36781	12	3240 lm	7 1/2"	1 Pc./Box
36782	24	5280 lm	13 1/2"	1 Pc./Box
36784	60	13200 lm	31 1/2"	1 Pc./Box

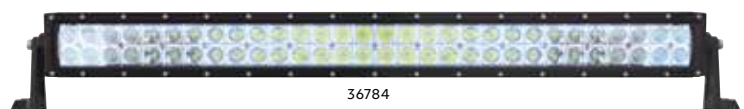

3 LED Dual Function Mini Auxiliary/Utility Light With Bezel & Washer

DESCRIPTION

- 3 LED mini dual function clearance marker light with stainless steel bezel
- Requires 3/4" diameter hole for installation
- Fits panels and bumpers up to 1/4" thick
- Include nylon backing washer when mounting on thin body panels
- Energy efficient LEDs with 10mA amp draw on low, 40mA on high

Item #	LEDs	Lens	Pack	Box
36600	3 Amber	Amber	1 Pc.	Card
36601	3 Red	Red	1 Pc.	Card
36602	3 Amber	Clear	1 Pc.	Card
36603	3 Red	Clear	1 Pc.	Card



10 LED 6" Oval Utility Light - White LED/Clear Lens

DESCRIPTION

- 10 LED 6" oval utility light
- 2 contact female plug
- Recommended plug: item #34215, lifetime warranty

Item #	LEDs	Lens	Pack	Bulk
36773B	10 White	Clear	1 Pc.	Bulk
36773BCK	10 White	Clear	1 Pc.	Bulk



39 High Power LED Dome Light

DESCRIPTION

- 39 High Power LED, 7 1/4" Round Dome Light w/ Chrome Bezel
- 12V/24V Application, **6 Month Warranty**

Item #	LEDs	Description	Pack	Carton
37626B	39	LED Dome Light	1 Pc.	Bulk



21 High Power LED Dome Light

DESCRIPTION

- 21 High Power LED, 6 1/4" Round Dome Light w/ Chrome Bezel
- 12V/24V Application, **6 Month Warranty**

Item #	LEDs	Description	Pack	Carton
37625B	21	LED Dome Light	1 Pc.	Bulk



INCANDESCENT CLEARANCE MARKERS

2-1/2" Round Light (Clearance/Marker)

DESCRIPTION

- Polycarbonate lens sonically sealed to housing to prevent moisture intrusion
- Rear plastic housing with standard 2-pin female contact plugs
- Recommends use with standard 2-pin male plugs, available separately, item # 34210

Item #	Lens	Pack	Carton
31061	Amber	1 Pc.	Bulk
31065	Red	1 Pc.	Bulk
31061AK	Amber	1 Kit	Bulk
31065RK	Red	1 Kit	Bulk



2-1/2" Round Reflectorized Light (Clearance/Marker)

DESCRIPTION

- Polycarbonate lens sonically sealed to housing to prevent moisture intrusion
- When not light, lens act as reflector and provide additional safety for rigs or trailers
- Rear plastic housing with standard 2-pin female contact plugs
- Recommends use with standard 2-pin male plugs, available separately, item # 34210

Item #	Lens	Pack	Carton
31059	Red Reflectorized	1 Pc.	Bulk
31055AK	Amber Reflectorized	1 Kit	Bulk
31059RK	Red Reflectorized	1 Kit	Bulk



2-1/2" Round Beehive Light (Clearance/Marker)

DESCRIPTION

- 2-1/2" beehive clearance/marker light with 2 female terminals
- Polycarbonate lens sonically sealed to housing to prevent moisture intrusion
- Recommended plug: item # 34210
- Kit Includes Light, Grommet Item # 31503 and Plug Item # 34210

Item #	Lens	Pack	Carton
30168	Red	1 Pc.	20/Carton

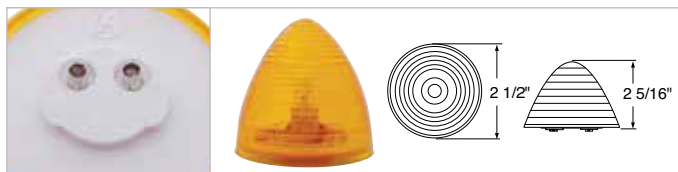

Tiger Eye Light (Clearance/Marker) With White Base

DESCRIPTION

- Tiger Eye Clearance/Marker Light with 2 Incandescent 194 Bulbs
- Acrylic Lens Snap Seals onto ABS Housing
- Single Wire, Self Grounding

Item #	Lens	Base	Pack	Carton
30005	Amber	White	1 Pc.	Bulk
30008	Red	White	1 Pc.	Bulk



Dual Bulbs Rectangular Light (Clearance/Marker)

DESCRIPTION

- Rectangular Clearance/Marker Light with 2 Bulbs
- Kit Includes Light and Mounting Base (Item # 30919 or 33006)
- Recommended Mounting Base: Item # 30919 (Chrome) or Item # 33006 (Black)

Item #	Lens	Base	Pack	Carton
30051	Amber	None	1 Pc.	Bulk
30055	Red	None	1 Pc.	Bulk
30051AK-B	Amber	Black	1 Kit	Bulk
30051AK-C	Amber	Chrome	1 Kit	Bulk
30055RK-B	Red	Black	1 Kit	Bulk
30055RK-C	Red	Chrome	1 Kit	Bulk



Incandescent Rectangular Fender Mount Light (Clearance/Marker)

DESCRIPTION

- Functions as both front and rear clearance light for trailers over 80 inches wide
- High quality injection molded dual color, amber and red plastic lens
- Polycarbonate lens sonically sealed to housing to prevent moisture intrusion
- Grease filled terminals to prevent corrosion
- Recommend mounting/quick-connect base: item # 30919 (chrome) or item # 33006 (black)

Item #	Description	Base	Pack	Carton
31050	Fender - Mount	None	1 Pc.	Bulk
31050ARK-B	Fender - Mount	Black	1 Kit	Bulk



4" Round Dual Function Turn Signal Light

DESCRIPTION

- Injection molded high quality polycarbonate lens
- Polycarbonate lens sonically sealed to housing to prevent moisture intrusion
- Rear plastic housing with standard female contact plug and grease filled terminal to prevent corrosion
- Dual function incandescent bulb included, compatible with 2-pin or 3-pin plug
- Shock mount designed to absorb shock and prolong bulb life

Item #	Lens	Pack	Carton
31101	Amber	1 Pc.	Bulk
31109	Red	1 Pc.	Bulk
31101AK	Amber	1 Kit	Bulk
31109RK	Red	1 Kit	Bulk

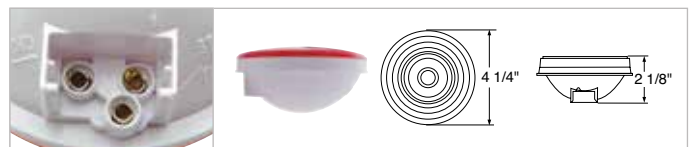

INCANDESCENT CLEARANCE MARKERS

Rectangular Light (Clearance/Marker) With Reflex Lens & Black Base

DESCRIPTION

- Rectangular clearance/marker light with black mounting base
- Single stud, shock absorbing housing

Item #	Lens	Pack	Carton
36012	Amber	1 Pc.	Bulk

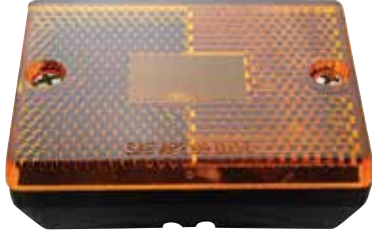

Rectangular Light (Clearance/Marker) With Reflex Lens

DESCRIPTION

- Rectangular clearance/marker light
- Single stud, shock absorbing housing
- Single wire, self grounding

Item #	Lens	Pack	Carton
36008	Amber	1 Pc.	Bulk



Single Bulb Rectangular Light (Clearance/Marker)

DESCRIPTION

- Rectangular clearance/marker light with 1 bulb and 2 female terminals
- Polycarbonate lens sonically sealed to housing to prevent moisture intrusion
- Recommend use with mounting base, item #33002

Item #	Lens	Pack	Carton
30141	Amber	1 Pc.	Bulk
30145	Red	1 Pc.	Bulk
30141AK-C	Amber	1 Kit	Bulk
30145RK-B	Red	1 Kit	Bulk
30145RK-C	Red	1 Kit	Bulk



Rectangular Light (Clearance/Marker) With White Base

DESCRIPTION

- Snap seal rectangular clearance/marker light
- Single wire, self grounding

Item #	Lens	Base	Pack	Carton
30020	Amber	White	1 Pc.	Bulk

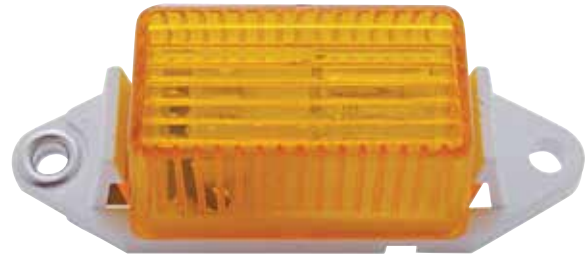

Large Narrow-Rail Light (Clearance/Marker)

DESCRIPTION

- Gray steel housing with mounting pad and high guard
- Flat back design eliminates the need for socket holes
- Single wire, self grounding

Item #	Lens	Pack	Carton
36014	Amber	1 Pc.	Bulk

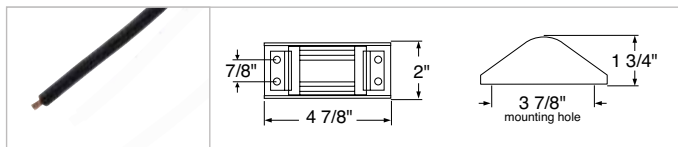

6" Oval Turn Signal Light

DESCRIPTION

- Injection molded high quality polycarbonate lens
- Polycarbonate lens sonically sealed to housing to prevent moisture intrusion
- Shock mount designed to absorb shock and prolong bulb life
- Rear plastic housing with standard 3-pin female contact plugs and grease filled terminal to prevent corrosion
- Recommends standard 3-pin male plug, available separately, item # 34212/34216
- Recommends mounting with standard 6" oval rubber push-in grommet, available separately, item # 31506

Item #	Lens	Pack	Carton
31361	Amber	1 Pc.	Bulk
31362	Red	1 Pc.	Bulk
31362RK	Red	1 Kit	Bulk



Rectangular Turn Signal Light

DESCRIPTION

- Injection molded high quality polycarbonate lens
- Polycarbonate lens sonically sealed to housing to prevent moisture intrusion
- Shock mount designed to absorb shock and prolong bulb life
- Rear plastic housing with standard 3-pin female contact plugs and grease filled terminal to prevent corrosion
- Recommends standard 3-pin male plug, available separately, item # 34211/34215
- Recommends mounting with our rectangular rubber push-in grommet, available separately, item # 31516

Item #	Lens	Pack	Carton
36409	Amber	1 Pc.	Bulk
31364	Red	1 Pc.	Bulk
36409AK	Amber	1 Kit	Bulk



Universal Stud-Mount Light With License Light (Stop, Turn & Tail)

DESCRIPTION

- Functions as stop, turn, tail, back-up and license light
- Stud mount, self grounding

Item #	Description	Pack	Carton
31126	w/ License Light	1 Pc.	Bulk

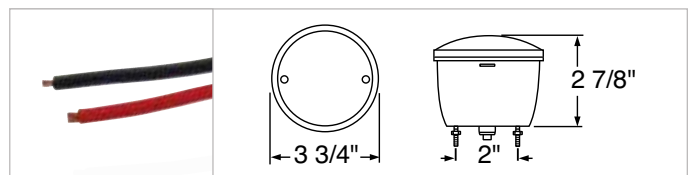

INCANDESCENT S/S/T, P/T/C LIGHTS

6" Oval Mid Trailer Turn Signal Light

DESCRIPTION

- Mid-trailer light provides side marker light and side reflector functions
- Polycarbonate lens sonically sealed to housing to prevent moisture intrusion
- Shock mount designed to absorb shock and prolong bulb life
- Rear plastic housing with standard 3-pin female contact plugs and grease filled terminal to prevent corrosion
- Recommends standard 3-pin male plug, available separately, item # 34212/34216
- Recommends mounting with standard 6" oval rubber push-in grommet, available separately, item # 31506

Item #	Description	Pack	Carton
31321	Amber	1 Pc.	Bulk

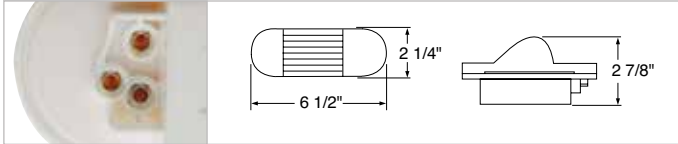

Universal Combination Tail Light

DESCRIPTION

- Functions as stop, turn, tail, back-up and license light
- Acrylic optic reflectorized lens
- Polycarbonate black housing with rear harness connection
- Three bolt mount on 2" triangle pattern

Item #	Description	Pack	Carton
36379	Combination Tail Light	1 Pc.	Bulk



Over 80" Wide Rectangular Submersible Combination Tail Light Without License Light

DESCRIPTION

- Designed with acrylic lens and high impact housing
- Gaskets create air pocket preventing water entry
- Meets DOT requirements for stop, turn and tail, rear and side reflector, side marker, and license
- Designed with acrylic lens and high impact housing
- Gaskets create air pocket preventing water entry
- Meets DOT requirements for stop, turn and tail, rear and side reflector, side marker, and license

Item #	Description	Pack	Carton
31165	w/o License Light	1 Pc.	Bulk





Under 80" Wide Combination Light

DESCRIPTION

- Designed with acrylic lens and high impact housing
- Standard 2" stud mounting
- Meets DOT requirements for stop, turn and tail, rear and side reflector, side marker, and license
- Includes rear clearance light for application
- Designed with acrylic lens and high impact housing
- Standard 2" stud mounting
- Meets DOT requirements for stop, turn and tail, rear and side reflector, side marker, and license
- Includes rear clearance light for application

Item #	Description	Pack	Carton
31131	w/o License Light	1 Pc.	Bulk
31132	w/ License Light	1 Pc.	Bulk

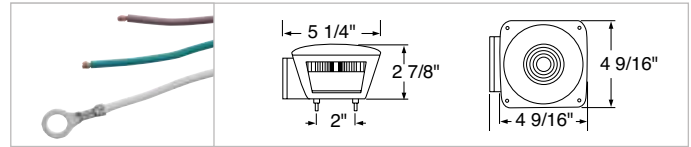

Over 80" Wide Combination Light Without License Light

DESCRIPTION

- Designed with acrylic lens and high impact housing
- Standard 2" stud mounting
- Meets DOT requirements for stop, turn and tail, rear and side reflector, side marker, and license
- Includes rear clearance light for application
- Passenger side application

Item #	Description	Pack	Carton
31133	w/o License Light	1 Pc.	Bulk
31134	w/ License Light	1 Pc.	Bulk

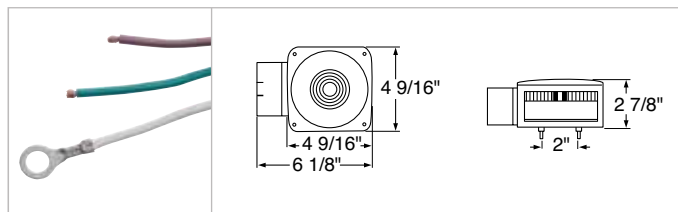

Over 80" Wide Submersible Combination Tail Light

DESCRIPTION

- Over 80" Wide Submersible Combination Tail Light
- Designed with Acrylic Lens and High Impact Housing
- Gaskets Create Air Pocket Preventing Water Entry
- Meets DOT Requirements for Stop, Turn and Tail Rear and Side Reflector, Side Marker, and License

Item #	Description	Pack	Carton
31135	w/o License Light	1 Pc.	Bulk
31136	w/ License Light	1 Pc.	Bulk

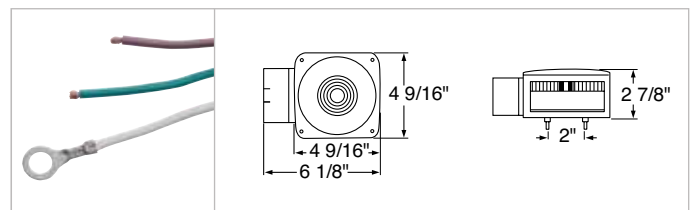

INCANDESCENT S/S/T, P/T/C LIGHTS

Under 80" Wide Combination Light Kit

DESCRIPTION

- Designed with acrylic lens and high impact housing
- Standard 2" stud mounting
- Meets DOT requirements for stop, turn and tail, rear and side reflector, side marker, and license
- Includes rear clearance light for application
- Kit includes 2 stop and tail lights, 2 amber side marker lights, 25' trailer wire harness, 4' trunk connector, license bracket & all mounting gear

Item #	Description	Pack	Carton
33130	Under 80" Trailer Light	1 Kit	Bulk



Over 80" Wide Submersible Combination Tail Light Kit

DESCRIPTION

- Designed with acrylic lens and high impact housing
- Standard 2" stud mounting
- Meets DOT requirements for stop, turn and tail, rear and side reflector, side marker, and license
- Gaskets create air pocket preventing water entry
- Kit includes 2 stop and tail lights, 2 amber side marker lights, 25' trailer wire harness, 4' trunk connector, license bracket & all mounting gear

Item #	Description	Pack	Carton
33133	Over 80" Trailer Light	1 Kit	Bulk



Double Face Tow Light Kit

DESCRIPTION

- Magnetic tow light kit, ideal for tow trucks, mobile homes, and RVs
- Kit features two double face warning lights with magnetic base, trunk and trailer harness, and connectors
- 25' four-wire harness plugs into standard flat four way trailer connector

Item #	Description	Pack	Carton
33135	Tow Light	1 Kit	Bulk



Mini Identification Light Bar - Amber

DESCRIPTION

- Identification bar light for over 80" applications
- Designed for installation with minimal space requirement
- Steel bar is powder coated in white finish with three lights
- Mounts on 14 3/8" centers
- Grounds through mounting screw
- Pre-wired light bar for easy installation

Item #	Lens	Pack	Carton
31076	Amber	1 Pc.	Bulk
31077	Red	1 Pc.	Bulk

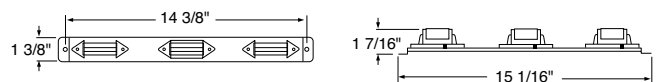
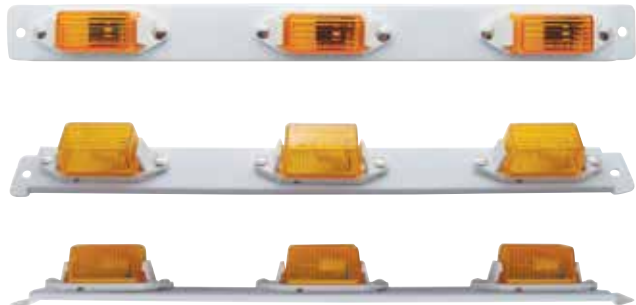



Sealed Identification Light Bar

DESCRIPTION

- Identification bar light for over 80" applications
- Black polycarbonate bar with three sealed lights
- Mounts on 8 1/2" centers
- Grounds through mounting screw
- Pre-wired light bar for easy installation

Item #	Lens	Pack	Carton
31079	Amber	1 Pc.	Bulk
31080	Red	1 Pc.	Bulk

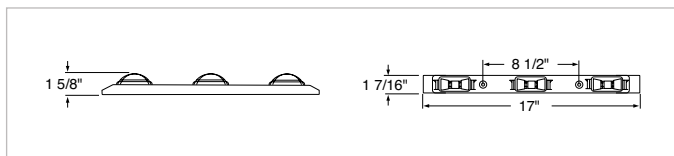

4" Back-Up Light - Clear Lens

DESCRIPTION

- Injection molded high quality polycarbonate lens
- Polycarbonate lens sonically sealed to housing to prevent moisture intrusion
- Shock mount designed to absorb shock and prolong bulb life
- Rear plastic housing with standard 3-pin female contact plugs and grease filled terminal to prevent corrosion
- Recommends standard 3-pin male plug, available separately, item # 34211/34215
- Recommends mounting with standard 4" round rubber push-in grommet, available separately, item # 31515

Item #	Description	Pack	Carton
31106	4" Back-Up	1 Pc.	Bulk
31106CK	4" Back-Up	1 Kit	Bulk



6" Oval Back-Up Light - Clear Lens

DESCRIPTION

- Injection molded high quality polycarbonate lens.
- Polycarbonate lens sonically sealed to housing to prevent moisture intrusion.
- Shock mount designed to absorb shock and prolong bulb life.
- Rear plastic housing with standard 3-pin female contact plugs and grease filled terminal to prevent corrosion.
- Recommends standard 3-pin male plug, available separately, item # 34212/34216.
- Recommends mounting with standard 6" oval rubber push-in grommet, available separately, item # 31506.

Item #	Description	Pack	Carton
31251	Oval Back-Up	1 Pc.	Bulk
31251CK	Oval Back-Up	1 Kit	Bulk



Rectangular Back-Up Light

DESCRIPTION

- Injection molded high quality polycarbonate lens
- Polycarbonate lens sonically sealed to housing to prevent moisture intrusion
- Shock mount designed to absorb shock and prolong bulb life
- Rear plastic housing with standard 3-pin female contact plugs and grease filled terminal to prevent corrosion
- Recommends standard 3-pin male plug, available separately, item # 34211/34215
- Recommends mounting with our rectangular rubber push-in grommet, available separately, item # 31516

Item #	Description	Pack	Carton
36410	Rectangular Back-Up	1 Pc.	Bulk
36410CK	Rectangular Back-Up	1 Kit	Bulk



INCANDESCENT BACK-UP & LICENSE LIGHTS

Rectangular Utility Light (Clearance/Marker) - Clear

DESCRIPTION

- Rectangular utility light with 1 bulb and 2 female terminals
- Recommended mounting base: item #33002

Item #	Description	Pack	Carton
30143	Clear	1 Pc.	Bulk



Item #33002



Incandescent Rectangular Fender Mount Utility Light - Clear Lens

DESCRIPTION

- Rectangular utility light with 2 bulbs
- Recommend base: item # 30919 (chrome) or item #33006 (black)

Item #	Description	Pack	Carton
31039	Clear	1 Pc.	Bulk



Item #30919



Chrome License Light

DESCRIPTION

- Rectangular license light with chrome housing
- 2 wires (hard wired)

Item #	Description	Pack	Carton
30362	White	1 Pc.	Bulk



Incandescent License Light With Chrome Plated Steel Housing & Mounting Bracket

DESCRIPTION

- License light with chrome plated steel housing and mounting bracket
- Surface mount on 2" center
- 1 Wire, ground through mounting screws

Item #	Description	Pack	Carton
33136B	License Light	1 Pc.	Bulk



License Light

DESCRIPTION

- Chrome plated license light
- 2 units required for legal license illumination
- Surface mounts on 2 5/8" mount

Item #	Description	Pack	Carton
33137	License Light	1 Pc.	Bulk

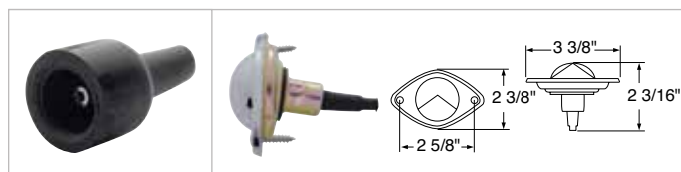

Snap-Fit License Light

DESCRIPTION

- Snap-fit license light designed for 1 1/4" diameter hole
- Ideal for courtesy, interior instrument and license light
- 2 units required for legal illumination

Item #	Description	Pack	Carton
30361	Snap-In License Light	1 Pc.	Bulk

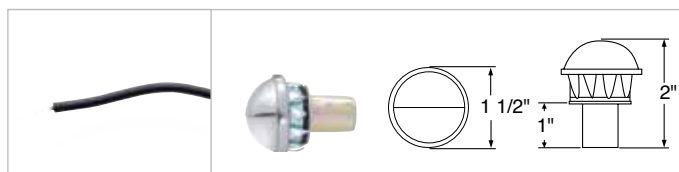

Rectangular License Light

DESCRIPTION

- Rectangular license light
- Surface mount on 1 3/4" center
- 1 wire, ground through mounting screw

Item #	Description	Pack	Carton
31401	Chrome	1 Pc.	Bulk
33138	Gray	1 Pc.	Bulk



License Light With Bracket

DESCRIPTION

- Polycarbonate lens and ABS housing
- Black powder-coated
- Steel license plate bracket riveted to light
- Surface mount on 3 1/2" centers

Item #	Description	Pack	Carton
33139	License Light	1 Pc.	Bulk



INCANDESCENT BACK-UP & LICENSE LIGHTS

Interior Dome Light

DESCRIPTION

- Durable polycarbonate lens with on-off toggle switch
- 12 volt interior dome light used for general illumination
- Mounts on 3 1/2" center

Item #	Description	Pack	Carton
31402	Dome Light	1 Pc.	Bulk



Interior Dome Light With Bulb & On-Off Switch Clear Lens

DESCRIPTION

- Quality acrylic clear lens
- Chrome plated ABS housing
- On-off toggle switch
- 12V DC, 1156 type bulb included
- Easy wiring with 2 wire leads

Item #	Description	Pack	Carton
31427	Clear Lens	1 Pc.	Bulk

PAR 36 Rubber Work Light

DESCRIPTION

- Durable synthetic rubber housing resists corrosion
- Rubber housing cushions trapezoidal seal beam from shock and vibration
- Mounts on swivel base bracket
- Universal 5/16" mounting stud
- Mounting hardware allows mounting in any position

Item #	Description	Pack	Carton
36451	PAR 36 Rubber Work Light	1 Pc.	Bulk



3-3/16" Round Quick Mount Reflector

DESCRIPTION

- 3-3/16" round quick mount reflector
- Durable acrylic lens
- Hermetically sealed acrylic lens with adhesive backing
- Available with amber lens

Item #	Color	Size	Pack	Carton
30713	Amber	3 3/16"	1 Pc.	Bulk
30714	Red	3 3/16"	1 Pc.	Bulk

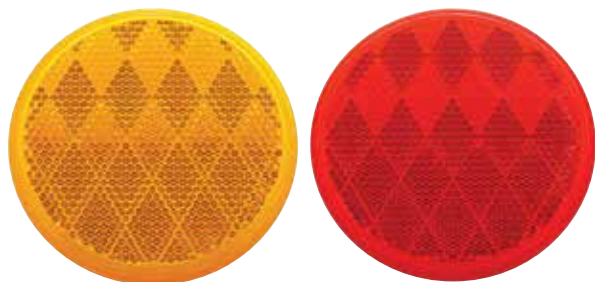

4" X 2" Oval Quick Mount Reflector

DESCRIPTION

- 4" X 2" oval quick mount reflector
- Durable acrylic lens
- Hermetically sealed acrylic lens with adhesive backing
- Available with amber lens

Item #	Color	Size	Pack	Carton
30711	Amber	4 5/16" x 1 7/8"	1 Pc.	Bulk
30712	Red	4 5/16" x 1 7/8"	1 Pc.	Bulk

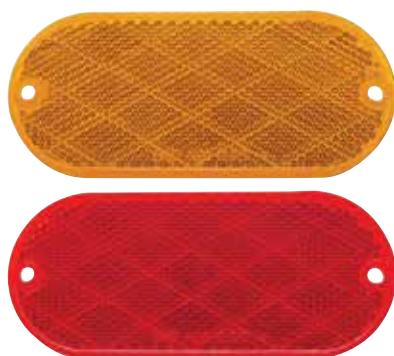

3 3/16" Round Reflector w/ Aluminum Mounting Base

DESCRIPTION

- 3 3/16" Round Reflector
- Acrylic Lens
- Hermetically Sealed Acrylic Lens with Aluminum Mounting Base

Item #	Color	Size	Pack	Carton
30709	Amber	3 3/16"	1 Pc.	Bulk
30710	Red	3 3/16"	1 Pc.	Bulk



2 3/16" Round Quick Mount Reflector

DESCRIPTION

- Durable acrylic lens
- Hermetically sealed acrylic lens with adhesive backing

Item #	Color	Size	Pack	Carton
30726	Red	2 3/8"	1 Pc.	Bulk



Rectangular Quick Mount Reflector With Chrome Bezel

DESCRIPTION

- Rectangular quick mount reflector with chrome bezel
- Durable acrylic lens
- Hermetically sealed acrylic lens with adhesive backing
- Available with amber lens

Item #	Color	Size	Pack	Carton
30703	Amber	3 1/2" x 1 3/4"	1 Pc.	Bulk
30704	Amber	3 1/2" x 1 3/4"	1 Pc.	Bulk

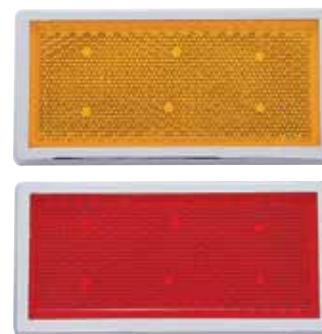

Round Center Bolt Reflector

DESCRIPTION

- Round Center Bolt Reflector
- Acrylic Lens, Available in 2 3/8" or 3 3/16"
- Hermetically Sealed Acrylic Lens with Center Mounting Holes

Item #	Color	Size	Pack	Carton
30723	Amber	3 3/16"	1 Pc.	Bulk
30724	Red	3 3/16"	1 Pc.	Bulk



MOUNTING ACCESSORIES

Stainless 6" Oval Mounting Flange

DESCRIPTION

- Stainless 6" oval mounting flange
- Universal design fits any 6" oval light

Item #	Description	Pack	Bulk
20487B	6" Oval Mounting Flange	1 Pc.	Bulk



Stainless Steel Mirror Light Bracket

DESCRIPTION

- Highly polished 304 premium grade stainless steel for durability and shine
- Flexible use for vertical or horizontal mount
- Perfect for mirror mounted double face lights
- recommended corresponding lights : item # 38701, 39438
- Dimension: 4" L X 2" W X 1-1/2" H

Item #	Description	Pack	Card
60054	SS Mirror Bracket	1 Pc.	Card



Stainless Steel Mounting Bezel For 4" Round Light

DESCRIPTION

- Highly polished 304 grade stainless steel
- Specially design to mount lights without the need for rubber grommet
- Includes stainless steel hardware
- Security bezel, theft deterrent design
- Shipped in store-ready retail packaging

Item #	Description	Pack	Card
20549	Mounting Bezel 4" Round	1 Pc.	Card
20549B	Mounting Bezel 4" Round	1 Pc.	Bulk



International Stainless Backup Light Bracket

DESCRIPTION

- Stainless steel backup light bracket for International trucks
- 430 stainless steel
- Hardware not included, sold in pairs

Item #	Description	Pack	Box
29072	Intl. Backup Light Bracket	1 Pair	Wbox



4" Chrome Mounting Bezel

DESCRIPTION

- Chrome plastic mounting bezel
- Beautiful high quality chrome plated finish with triple chrome plating process
- Specially design to mount lights without the need of rubber grommets

Item #	Description	Pack	Carton
10500B	4" Mounting Bezel	1 Pc.	Bulk



2" Gray Mounting Bezel

DESCRIPTION

- Gray plastic mounting bezel
- Specially design to mount lights without the need of rubber grommets

Item #	Description	Pack	Carton
10518B	2" Mounting Bezel	1 Pc.	Bulk

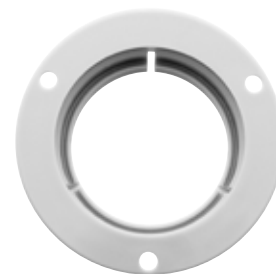

2" Grommet - Flush Mount

DESCRIPTION

- Black rubber grommet for 2" light
- Flush mount
- Provides lamps with additional shock and vibration absorbency

Item #	Color	Pack	Carton
31505	Flush Mount	1 Pc.	Bulk
31507	Branch Deflector	1 Pc.	Bulk



2-1/2" Grommet - Wide Lip

DESCRIPTION

- Black rubber grommet for 2 1/2" light
- Provide additional shock and vibration resistance

Item #	Color	Pack	Carton
31503	Flush Mount, Wide Lip	1 Pc.	Bulk
31504	Recess Mount, Narrow Lip	1 Pc.	Bulk
31508	Recess Mount, Closed Back	1 Pc.	Bulk



4" Grommet

DESCRIPTION

- Black rubber grommet for 4" light
- Provides lamps with additional shock and vibration absorbency

Item #	Description	Pack	Carton
31515	4" Round	1 Pc.	Bulk



Oval Grommet

DESCRIPTION

- Black rubber grommet for oval light
- Provides lamps with additional shock and vibration resistance

Item #	Description	Pack	Carton
31506	Oval	1 Pc.	Bulk



MOUNTING ACCESSORIES

Rectangular Grommet

DESCRIPTION

- Black rubber grommet designed for rectangular lights
- Provide lamps with additional shock and vibration absorbency

Item #	Color	Pack	Carton
31516	Rectangular	1 Pc.	Bulk



Mini Rectangular Grommet

DESCRIPTION

- Black rubber grommet designed for mini rectangular style lights
- Provide lamps with additional shock and vibration absorbency
- Fits truck-lite 45 series light

Item #	Color	Pack	Carton
31510	Mini Rectangular	1 Pc.	Bulk



Die Cast Tiger Eye Lens Guard

DESCRIPTION

- Chrome die cast lens guard for tiger eye clearance/marker light

Item #	Description	Pack	Carton
30001B	Chrome Die Cast	1 Pc.	Bulk



SS Rectangular Marker Lens Guard With Oval Cut Out

DESCRIPTION

- Stainless Steel Lens Guard for Rectangular Clearance/Marker Light

Item #	Color	Pack	Carton
30002B	With Oval Cut Out	1 Pc.	Bulk



Mounting Bracket

DESCRIPTION

- Mounting Bracket for Rectangular Clearance/Marker Light
- Available for 1 Bulb Small Rectangular Clearance/Marker Light

Item #	Description	Pack	Carton
33003B	Black	1 Pc.	Bulk
33002	Chrome	1 Pc.	Bulk



Mounting Bracket

DESCRIPTION

- Mounting bracket for rectangular clearance/marker light
- Available for 1 bulb small rectangular clearance/marker light

Item #	Color	Pack	Carton
33006	Black	1 Pc.	Bulk
30919	Chrome	1 Pc.	Bulk



Stainless Light Bracket With Single 2" Light Cutout

DESCRIPTION

- Highly polished 304 premium grade stainless steel for durability and shine
- Stainless steel light bracket with 2" light cutout
- Features one 2" light cutout

Item #	Material	Light Holes	Pack	Carton
20708	Stainless	1	1 Pc.	Bulk
20725	Stainless	2	1 Pc.	Bulk
34001	Steel/Black	1	1 Pc.	Bulk



Stainless Steel Light Bracket With Single Cutout For 2-1/2" Light

DESCRIPTION

- Highly polished 304 premium grade stainless steel for durability and shine.
- Stainless steel light bracket with 2-1/2" light cutout.
- Features 3" diameter cutout for use with 2-1/2" light and mounting grommet.
- Highly polished stainless steel with protective film to prevent scratches during shipping.

Item #	Material	Light Holes	Pack	Carton
20436	Stainless	1	1 Pc.	Bulk
20451	Stainless	3	1 Pc.	Bulk
34004	Steel/Black	1	1 Pc.	Bulk



MOUNTING ACCESSORIES

Stainless Light Bracket With Single Oval Light Cutout

DESCRIPTION

- Highly polished 304 premium grade stainless steel for durability and shine
- Stainless steel light bracket with 6" oval light cutout
- Features one 6" oval light cutout

Item #	Material	Light Holes	Pack	Carton
20401	Stainless	1	1 Pc.	Bulk
20404	Stainless	2	1 Pc.	Bulk
20407	Stainless	3	1 Pc.	Bulk
20397	Stainless	4	1 Pc.	Bulk
34014	Steel/Black	1	1 Pc.	Bulk



Stainless & Black Light Brackets With Single 4" Light Cutout

DESCRIPTION

- Highly polished 304 premium grade stainless steel for durability and shine
- Stainless steel light bracket with 4" light cutout
- Features one 4" light cutout

Item #	Material	Light Holes	Pack	Carton
20422	Stainless	1	1 Pc.	Bulk
20425	Stainless	2	1 Pc.	Bulk
20428	Stainless	3	1 Pc.	Bulk
34003	Steel/Black	1	1 Pc.	Bulk
34007	Steel/Black	1	1 Pc.	Bulk





6” Single Lead Wire With .180 Bullet Termination & Stripped End

DESCRIPTION

- Single lead wire
- 0.180” molded bullet plug
- 16 gauge insulated wires

Item #	Description	Pack	Carton
34213B	.180 Molded Male, Black	1 Pc.	Bulk
34214B	.180 Molded Male, White	1 Pc.	Bulk



2 Prong Plug Wiring Harness With 5 Plugs & 7” Lead

DESCRIPTION

- Quality molded male bullet plugs with 16 gauge insulated wires
- 7” wire lead inbetween each plug
- 5 Molded 2 wire plugs

Item #	Description	Pack	Carton
34224	2 Prong Plug / 5 Plugs	1 Pc.	Bulk
34224P	2 Prong Plug / 5 Plugs	1 Pc.	Retail

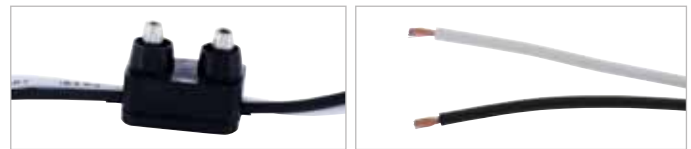

2-Prong Plug Wiring Harness With 6” Lead Between Plugs - 2 Plugs

DESCRIPTION

- Waterproof over-molded plug housing
- Quality insulated 16 gauge wire
- Pre-cut with different number of plugs, all with 6” wire lead in between, and pre-stripped wire end

Item #	Description	Pack	Carton
34242-2	2 Prong Plug / 2 Plugs	1 Pc.	Bulk



2-Prong Plug Wiring Harness With 6” Lead Between Plugs - 3 Plugs

DESCRIPTION

- Waterproof over-molded plug housing
- Quality insulated 16 gauge wire
- Pre-cut with different number of plugs, all with 6” wire lead in between, and pre-stripped wire end

Item #	Description	Pack	Carton
34242-3	2 Prong Plug / 3 Plugs	1 Pc.	Bulk



2-Prong Plug Wiring Harness With 6” Lead Between Plugs - 4 Plugs

DESCRIPTION

- Waterproof over-molded plug housing
- Quality insulated 16 gauge wire
- Pre-cut with different number of plugs, all with 6” wire lead in between, and pre-stripped wire end

Item #	Description	Pack	Carton
34242-4	2 Prong Plug / 4 Plugs	1 Pc.	Bulk



2-Prong Plug Wiring Harness With 6” Lead Between Plugs - 5 Plugs

DESCRIPTION

- Waterproof over-molded plug housing
- Quality insulated 16 gauge wire
- Pre-cut with different number of plugs, all with 6” wire lead in between, and pre-stripped wire end

Item #	Description	Pack	Carton
34242-5	2 Prong Plug / 5 Plugs	1 Pc.	Bulk



2-Prong Plug Wiring Harness With 6” Lead Between Plugs - 6 Plugs

DESCRIPTION

- Waterproof over-molded plug housing
- Quality insulated 16 gauge wire
- Pre-cut with different number of plugs, all with 6” wire lead in between, and pre-stripped wire end

Item #	Description	Pack	Carton
34242-6	2 Prong Plug / 6 Plugs	1 Pc.	Bulk





2-Prong Plug Wiring Harness With 6” Lead Between Plugs - 7 Plugs

DESCRIPTION

- Waterproof over-molded plug housing
- Quality insulated 16 gauge wire
- Pre-cut with different number of plugs, all with 6” wire lead in between, and pre-stripped wire end

Item #	Description	Pack	Carton
34242-7	2 Prong Plug / 7 Plugs	1 Pc.	Bulk



2-Prong Plug Wiring Harness With 6” Lead Between Plugs - 8 Plugs

DESCRIPTION

- Waterproof over-molded plug housing
- Quality insulated 16 gauge wire
- Pre-cut with different number of plugs, all with 6” wire lead in between, and pre-stripped wire end

Item #	Description	Pack	Carton
34242-8	2 Prong Plug / 7 Plugs	1 Pc.	Bulk

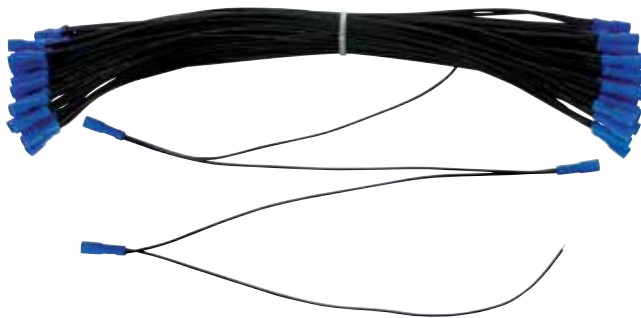

100’ Long 0.180” Female Bullet Plug Wire Harness 13” Lead

DESCRIPTION

- 100’ long with 13” lead
- Approximately 92 plugs

Item #	Description	Pack	Carton
34249	2 Prong Plug / 7 Plugs	1 Pc.	Bulk



2 Wire Pigtail With 2 Prong Plug - 6" Lead

DESCRIPTION

- Quality molded male bullet plugs with 16 gauge wires
- Typically use for clearance/marker light
- White ground wire with #10 crimped ring terminal
- Ships in bulk packaging

Item #	Description	Pack	Carton
34210	2 Wire Plug	1 Pc.	Bulk

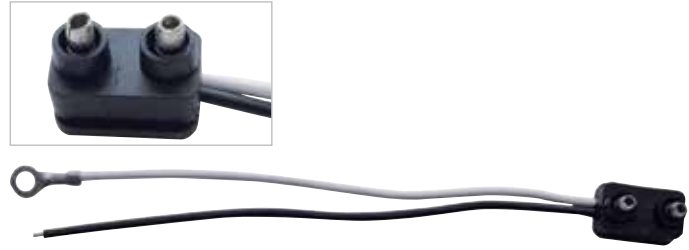

2 Prong Light (Clearance/Marker) Plug

DESCRIPTION

- 2 wire molded plug
- Ground wire with # 10 ring termination
- Black (hot) wire with .180 termination

Item #	Description	Pack	Carton
34255	2 Wire Plug	1 Pc.	Bulk

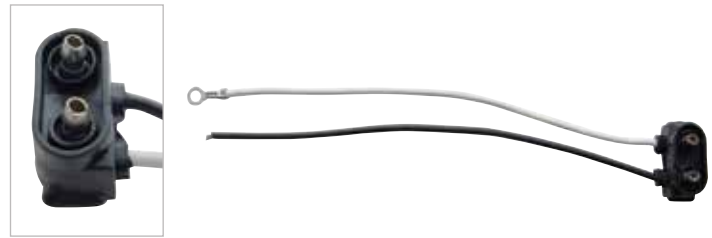

2 Wire Pigtail With 2 Prong Straight Plug - 12" Lead

DESCRIPTION

- 2 Wire molded plug
- Ground wire with # 10 ring termination
- 16 gauge wire
- Red (hot) wire stripped end
- Ships in bulk packaging

Item #	Description	Pack	Carton
34211	2 Wire Plug	1 Pc.	Bulk



2 Wire Pigtail With 2 Prong Right Angle Plug - 12" Lead

DESCRIPTION

- Quality molded male bullet plugs w/ 16 gauge insulated wires
- White ground wire with # 10 crimped ring terminal
- Fits 2" and 2-1/2" round marker lights
- Ships in bulk packaging

Item #	Description	Pack	Carton
34215	2 Wire Plug - Right Angle	1 Pc.	Bulk

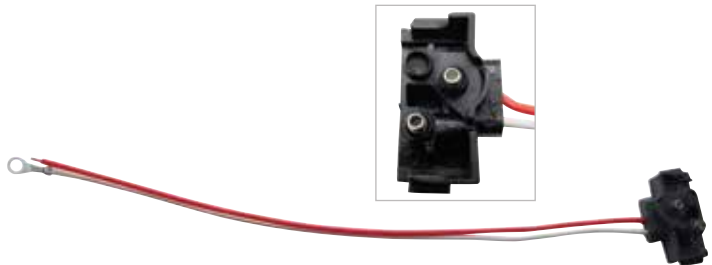

2 Wire Pin Plug

DESCRIPTION

- 2 wire molded plug adapter
- Ground wire with # 10 ring termination
- Red (hot) wire stripped end

Item #	Description	Pack	Carton
34270	2 Wire Plug	1 Pc.	Bulk





2 Wire Female Adapter With Pin Plug

DESCRIPTION

- Molded plug adaptor
- Female to female adaptor

Item #	Description	Pack	Carton
34271	2 Wire Adaptor	1 Pc.	Bulk



3 Wire Pigtail With 3 Prong Straight Plug - 12" Lead

DESCRIPTION

- Quality molded male bullet plugs w/ 16 gauge insulated wires
- White ground wire with # 10 crimped ring terminal
- Ships in bulk packaging

Item #	Description	Pack	Carton
34212	3 Wire Plug	1 Pc.	Bulk



3 Wire Pigtail With 3 Prong Right Angle Plug - 12" Lead

DESCRIPTION

- Quality molded male bullet plugs w/ 16 gauge insulated wires
- White ground wire with # 10 crimped ring terminal
- Black wire (tail/clearance), red wire (stop/turn)
- Ships in bulk packaging

Item #	Description	Pack	Carton
34216	3 Wire Plug - Right Angle	1 Pc.	Bulk



3 Wire Pin Plug

DESCRIPTION

- 16 gauge insulated wires
- White ground wire with # 10 ring termination

Item #	Description	Pack	Carton
34238	3 Wire Plug	1 Pc.	Bulk

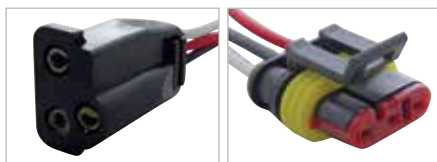

3-Way Molded Female Bullet Plug To 3-Way TE AMP Style 1.5mm Plug adapter

DESCRIPTION

- Quality 18 AWG wires
- 6" wire leads between the two plugs

Item #	Description	Pack	Carton
34236	3 Wire Adaptor	1 Pc.	Bulk

ELECTRICAL ACCESSORIES

Double Bullet Plug Wire Harness

DESCRIPTION

- Waterproof over-molded plug housing
- Quality insulated 16 gauge wire
- 0.180" female bullet type plug

Item #	Plug	Lead	Length	Pack	Carton
34194	200	4"	66'	1 Roll	1/Carton
34195	150	6"	74'	1 Roll	1/Carton
34196	150	8"	99'	1 Roll	1/Carton
34193	150	10"	124'	1 Roll	1/Carton
34197	100	12"	99'	1 Roll	1/Carton



100 Count 3-Prong Male Bullet Plugs Wire Harness Roll - 100' W/12" Lead Between Plugs

DESCRIPTION

- Waterproof over-molded plug housing
- Total 100' in length with 100 plugs spaced with 12" lead

Item #	Description	Pack	Carton
34244	3 Wire Plug x100'	1 Roll	1/Carton



100 Count 3-Prong Male Right Angle Bullet Plugs Wire Harness Roll - 100' W/12" Lead Between Plugs

DESCRIPTION

- Waterproof over-molded plug housing
- Total 100' in length with 100 plugs spaced with 12" lead

Item #	Description	Pack	Carton
34243	3 Wire Plug x100'	1 Roll	1/Carton



150 Count 3-Prong Female Bullet Plugs Wire Harness Roll - 74' W/6" Lead Between Plugs

DESCRIPTION

- Made specially for quick installation of 3-wire lights on commercial trucks and trailers
- Waterproof over-molded plug housing

Item #	Plug	Lead	Length	Pack	Carton
34191	150	6"	74'	1 Roll	1/Carton
34192	100	12"	98.5'	1 Roll	1/Carton





100' Long Primary Wire Roll - Red

DESCRIPTION

- 16 gauge primary wire
- Single conductor PVC jacket resists grease, oil, gasoline, acids & other abrasive materials
- Used for automotive, truck & marine applications
- Shipped in 100' rolled with plastic spool

Item #	Description	Pack	Carton
34118	Red	1 Roll	1/Carton
34119	Black	1 Pc.	1/Carton
34120	White	1 Pc.	1/Carton



100 Count 2-Prong Male Bullet Plugs 16G Wire Harness Roll - 100' W/12" Lead Between Plugs

DESCRIPTION

- Waterproof over-molded plug housing
- Quality insulated 16 gauge wire
- Total 100' in length with 100 plugs spaced with 12" lead

Item #	Description	Pack	Carton
34241	2 Wire Plug x 100'	1 Roll	1/Carton



200 Count 2-Prong Male Bullet Plugs 16G Wire Harness Roll - 100' W/6" Lead Between Plugs

DESCRIPTION

- Waterproof over-molded plug housing
- Quality insulated 16 gauge wire
- Total 100' in length with 200 plugs spaced with 6" lead

Item #	Description	Pack	Carton
34242	2 Wire Plug x 100'	1 Roll	1 Pc.



Round 7-Way Female Connector - Split Pin

DESCRIPTION

- 7-way female split pin connectors in zinc die-cast housing
- Built-in socket slant provides easy alignment and maximum contact
- Accepts wide range of wire gauges

Item #	Description	Pack	Carton
90500	7-Way Plug	1 Pc.	Bulk
90501	7-Way Socket	1 Pc.	Bulk



Round 4-Way Female Connector - Split Pin

DESCRIPTION

- 4-way female split pin connectors in zinc die-cast housing
- Built-in socket slant provides easy alignment and maximum contact

Item #	Description	Pack	Carton
90506	4-Way Plug	1 Pc.	Bulk
90507	4-Way Socket	1 Pc.	Bulk



Round 6-Way Female Connector - Split Pin

DESCRIPTION

- 6-Way Female Connectors in ABS Housing with PVC Boot
- 6-Way Male Connector in Chrome Plated Die Cast Housing
- Accepts Wide Range of Wire Gauges

Item #	Description	Pack	Carton
90504	6-Way Plug	1 Pc.	Bulk
90505	6-Way Socket	1 Pc.	Bulk



Round 7-Way Connector - Flat Pin

DESCRIPTION

- 7-Way Male and Female Flat Pin Connectors in ABS Black Housing
- Built-in Socket Slant Provides Easy Alignment and Maximum Contact
- Accepts Wide Range of Wire Gauges

Item #	Description	Pack	Carton
90502	7-Way Plug	1 Pc.	Bulk
90503	7-Way Socket	1 Pc.	Bulk



7 To 6-Way Harness Adaptor

DESCRIPTION

- Converts 7-Way Round Blade Connector to 6-Way Round Pin Connector
- Easily Adapts Tow Vehicle Connector to Trailer Connector
- Non-Corrosive Nylon Shell

Item #	Description	Pack	Carton
90602	7 To 6 Way Adaptor	1 Pc.	10/Carton



7 To 4-Way Harness Adaptor

DESCRIPTION

- Converts 7-Way Round Blade Connector to 4-Way Flat Connector
- Easily Adapts Tow Vehicle Connector to Trailer Connector
- Non-Corrosive Nylon Shell

Item #	Description	Pack	Carton
90601	7 To 4 Way Adaptor	1 Pc.	10/Carton



6 To 4-Way Harness Adaptor

DESCRIPTION

- Converts 6-Way Round Connector to 4-Way Flat Connector
- Easily Adapts Tow Vehicle Connector to Trailer Connector
- Non-Corrosive Nylon Shell

Item #	Description	Pack	Carton
90600	6 To 4 Way Adaptor	1 Pc.	10/Carton



ELECTRICAL ACCESSORIES

Trailer Light Converter - 5 To 4 Wires

DESCRIPTION

- Converts 5-Wire System to 4-Wire System
- 18G Bonded Wire with Flat 4-Way Female Connector

Item #	Description	Pack	Carton
90620	5 to 4 Wire Converter	1 Pc.	Bulk



Trailer Light Converter - 4 to 3 Wires

DESCRIPTION

- Converts 4-Wire System to 3-Wire System
- 18G Bonded Wire with 24" Wire on Each Side

Item #	Description	Pack	Carton
90621	4 to 3 Wire Converter	1 Pc.	Bulk



Trailer Light Converter - 3 to 2 Wires

DESCRIPTION

- Converts 3-Wire System to 2-Wire System
- 18G Bonded Wire with 12" Wire on Each Side

Item #	Description	Pack	Carton
90622	3 to 2 Wire Converter	1 Pc.	Bulk



Trailer Light Converter

DESCRIPTION

- 4 Pole Female Connector and Cover on One Side and 5 Wires on the other
- 18G Bonded Wire with 60" Wire Lead

Item #	Description	Pack	Carton
90623	4 Pole to 5 Wire Converter	1 Pc.	Bulk



4 Way LED Trailer Light Harness - 25' Positive & Ground Leads

DESCRIPTION

- Full 25' length on positive and ground leads
- Flat 4-across style male connector w/ 18 gauge insulated wire
- For use on the trailer side LED light wiring

Item #	Description	Pack	Carton
90624	25' Harness Kit	1 Pc.	Bulk

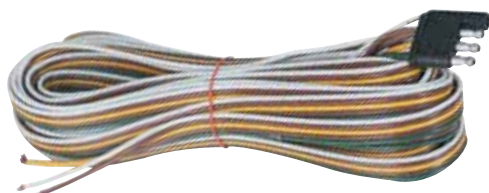

Quick Splice Wire Connector

DESCRIPTION

- Design for connecting 14 to 18 gauge wire in non-submersible applications
- Use for quick connections without wire stripping.

Item #	Description	Pack	Carton
40108	Wire Connector	1 Pc.	Bulk



IMPORTANT NOTE: Every lamp, reflex reflector, and conspicuity treatment (device) must be permanently attached in the location specified below and must comply with all applicable requirements prescribed for it by FMVSS/CMVSS 108. The face of any device on the front/rear and sides should be, respectively perpendicular and parallel to vehicle centerline, unless it is photometrically certified at installation angle. No part of the vehicle shall prevent any device from meeting its prescribed requirements unless an auxiliary device meeting all prescribed requirements is installed.

In Canada: Manufacturers and importers of vehicles must have the proper certification test records demonstrating compliance of lighting components with all prescribed requirements.

BASIC EQUIPMENT REQUIRED ON ALL TRUCKS, BUSES & MPVs

DESCRIPTION				MANDATORY REQUIREMENTS			
Area	Equipment	(SAE Lens Coding)	Functional Purpose	QTY	Color	Location	Height mm (in.) from the ground
1	Headlamps - Lower Beam	(H, HR) Attention: US: "DOT" lettering required on lens Attention: US & Canada: light source code required on lens	Forward road illumination	Minimum 2	White	On the front - symmetrical - as far apart as practicable (If 4 lamp system - outboard or above upper beams)	560-1370 (22-54)
	Headlamps - Upper Beam	(H, HR) Attention: US: "DOT" lettering required on lens Attention: US & Canada: light source code required on lens	Forward road illumination	Minimum 2	White	On the front - symmetrical (If 4 lamp system - inboard or below lower beams)	560-1370 (22-54)
	Parking Lamps - Attention: Required only on vehicles less than 2032mm wide	(P)	Indicate parked vehicle	Minimum 2	White or Yellow	Front - symmetrical - as far apart as practicable	380-1530 (15-60)
	Daytime Running Lamps - Attention: for Canada required, for US optional.	(Y2) Attention: for US, "DRL" lettering required on lens if device is not headlamp	Indicate in-use vehicle	Minimum 2	White or Yellow	Front - symmetrical - as far apart as practicable	380 (15) minimum Maximum depends on type of DRL
	Front Turn Signal/Hazard Warning Lamps	(I)	Indicate direction of turn / identify disabled vehicle	Minimum 2	Yellow	Front - symmetrical - as far apart as practicable	380-2110 (15-83)
2	Front Clearance Lamps- Attention: Required for vehicles 2032mm wide or wider	(P2, PC* or P3*,PC2) *photometrically certified at installation angle	Show vehicle's width	Minimum 2	Yellow	At widest point - symmetrical - on the front or near the front - facing forward	As high as practicable
3	Front Identification Lamps (ID)	(P2 or P3)	Indicate presence of a wide vehicle	Exactly 3	Yellow	on the front - center - horizontally spaced 150 mm (6 in.) to 300 mm (12 in.) apart	As high as practicable or on top of cab
4A	Front Side Marker Lamps	(P2, PC* or P3 ,PC2*) *photometrically certified at installation angle	Front and Rear side marker lamps / side	Minimum 2	Yellow	Each side at front - as far forward as practicable	380 (15) minimum
4B	Front Side Reflex Reflectors	(A)		Minimum 2	Yellow	At front - symmetrical - as far forward as practicable - facing sideward	380-1530 (15-60)
5A	Rear Side Marker Lamps **	(P2, PC* or P3, PC2*) *photometrically certified at installation angle	Reflex reflector indicate vehicle's presence and length	Minimum 2	Red	Each side at rear - as far back as practicable	380 (15) minimum
5B	Rear Side Reflex Reflectors** ** not required on Truck Tractors	(A)		Minimum 2	Red	Each side at rear - as far back as practicable - facing sideward	380-1530 (15-60)
6	Rear Clearance Lamps Attention: Required for vehicles 2032mm wide or wider, but not required on Truck Tractors	(P2, PC* or P3, PC2*) *photometrically certified at installation angle	Show vehicle's width-MAY NOT be combined with tail lamps	Minimum 2	Red	At widest point - symmetrical - on the rear or near the rear - facing rearward	As high as practicable-may be lower only if rear ID lamps are at the top
7	Rear Identification Lamps (ID) - Attention: Required for vehicles 2032mm wide or wider, but not required on Truck Tractors	(P2 or P3)	Indicate presence of a wide vehicle	Exactly 3	Red	Rear - center - horizontally spaced 150 mm (6 in.) to 300 mm (12 in.) apart, facing rearward	in Canada : at the top - maybe lower if door header narrower than 25mm in USA: as high as practicable
8	Tail Lamps	(T)	Indicate vehicle's presence and width	Minimum 2	Red	On the rear - symmetrical - as far apart as practicable	380-1830 (15-72)
	Stop Lamps	(S)	Indicate braking	Minimum 2	Red	On the rear - symmetrical - as far apart as practicable	380-1830 (15-72)
	Rear Turn Signal/Hazard Warning Lamps	(I)	Indicate direction of turn/ identifies disabled veh.	Minimum 2	Red or Yellow	On the rear - symmetrical - as far apart as practicable	380-2110 (15-83)
	Rear Reflex Reflectors	(A)	Show vehicle's presence and width	Minimum 2	Red	On the rear - symmetrical - as far apart as practicable - facing rearward	380-1530 (15-60)
9	Backup Lamp	(R)	Illuminate ground behind the vehicle and alert road users	Minimum 1	White	Rear	No requirement
10	License Plate Lamp(s)	(L)	Illuminates license plate	Minimum 1	White	On the rear - above or at the sides of license plate	No requirement
11	Center High Mounted Stop Lamp - Attention: Required for vehicles less than 2032mm wide and 4536kg	(U3)	Indicates braking	Minimum 1	Red	On the rear - centerline of the vehicle	860 (34) minimum

FEDERAL REGULATIONS

ADDITIONAL EQUIPMENT FOR SPECIFIC VEHICLES

Vehicles 9.1 m (30 ft.) Long or Longer

DESCRIPTION				MANDATORY REQUIREMENTS			
Area	Equipment	(SAE Lens Coding)	Functional Purpose	QTY	Color	Location	Height mm (in.) from the ground
12A	Intermediate Side Marker Lamps	(P2 or PC)	Indicate presence of a long vehicle	Minimum 2	Yellow	Each side near center	380 (15) minimum
12B	Intermediate Side Reflex Reflectors	(A)	Indicate presence of a long vehicle	Minimum 2	Yellow	Each side near center - facing sideward	380-1530 (15-60)

Truck Tractors

MANDATORY REQUIREMENTS							
Area	Conspicuity Treatment	DOT Code	Quantity	Color	Location	Height	Options
13	Rear Upper Body Marking	DOT-C, DOT-C2, DOT-C3, or DOT-C4	Exactly 2 pairs of 300mm long strips	White	Rear upper corners of cab - facing rearward	As high as practicable excluding fairings	
14	Rear Marking	DOT-C, DOT-C2, DOT-C3, or DOT-C4	Indicate presence of a long vehicle	Red/White	Rear - facing rearward - on fenders, on mud flaps brackets, or within 300mm below of the top of mud flaps	As horizontal as practicable and not higher than 1525 mm from the ground	If mud flaps not used - on the cab or frame mounted brackets

TRUCK, BUS, MPV EQUIPMENT LOCATION REQUIREMENT

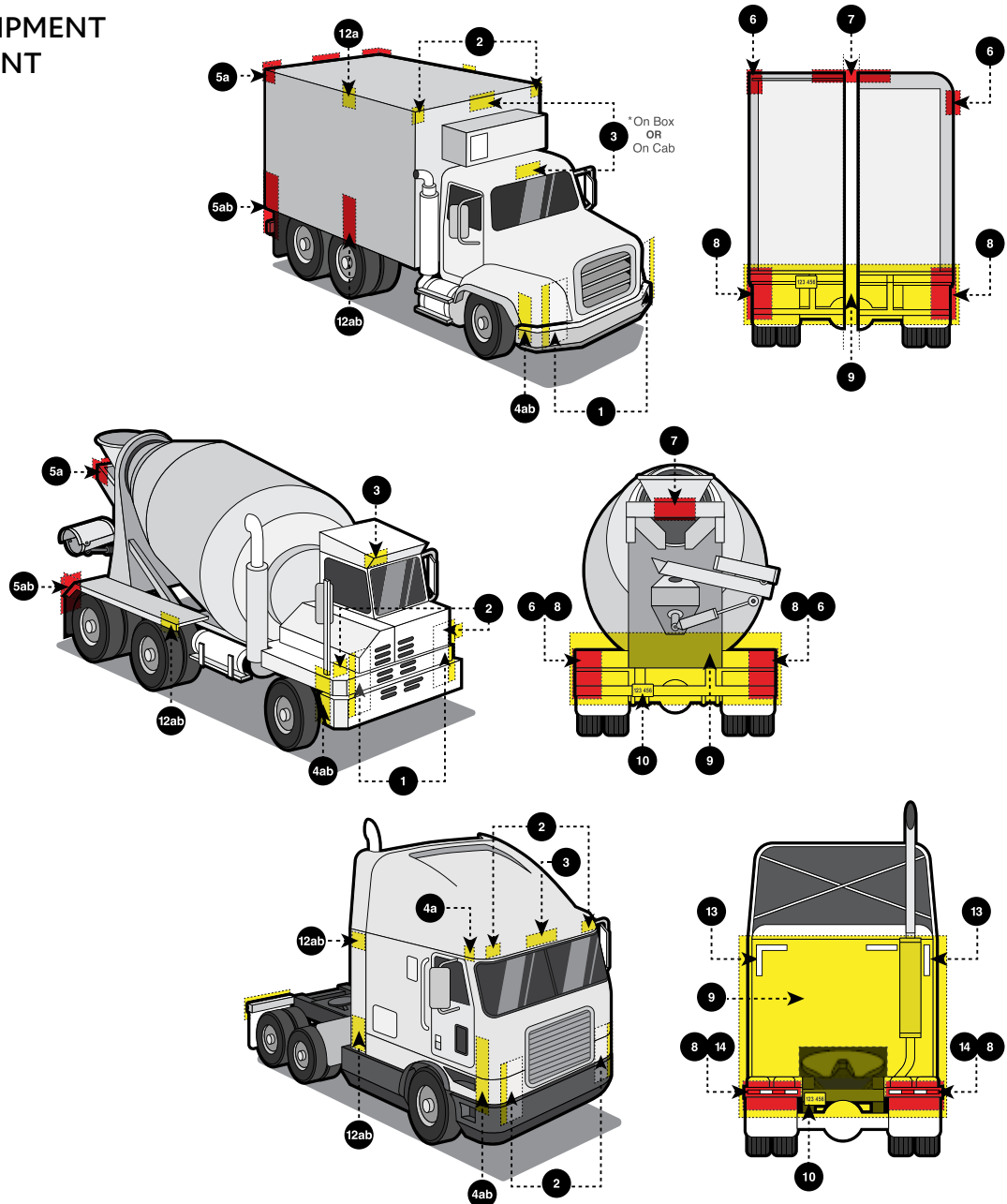

TRUCK, BUS, MPV EQUIPMENT LOCATION REQUIREMENT

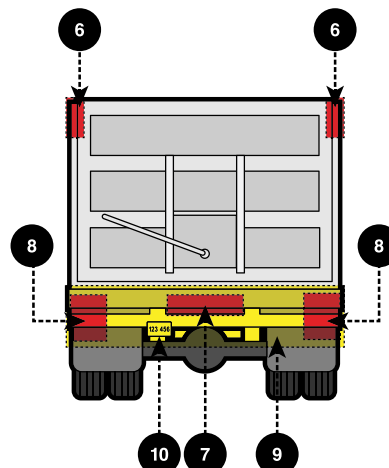
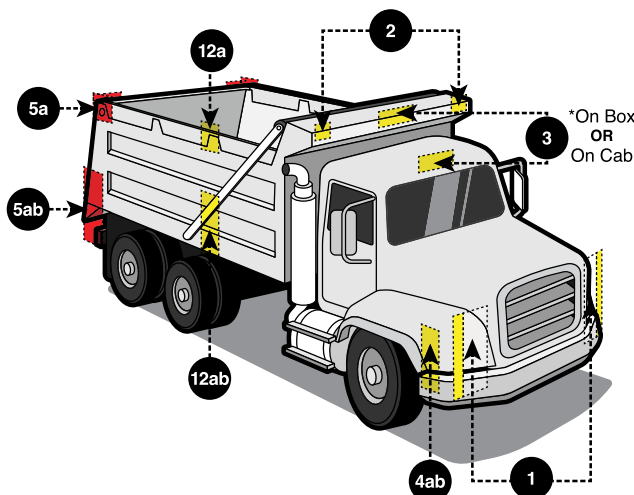
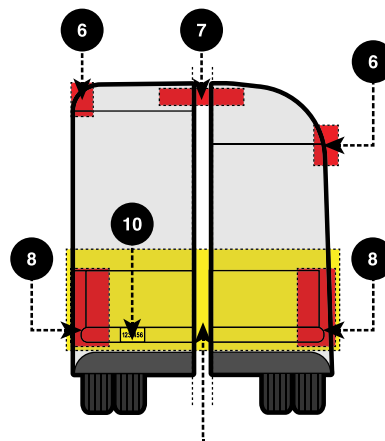
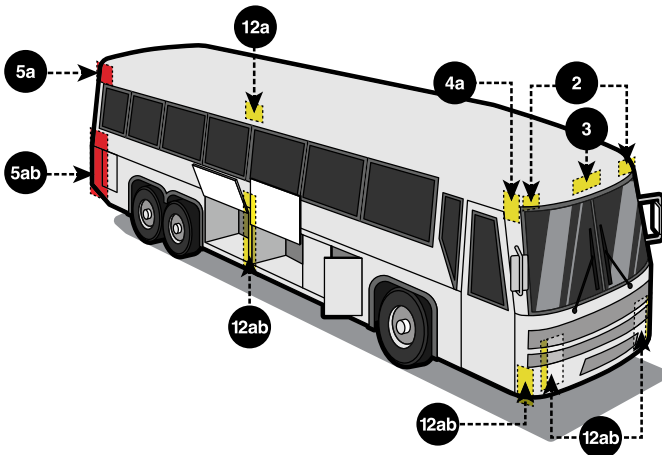
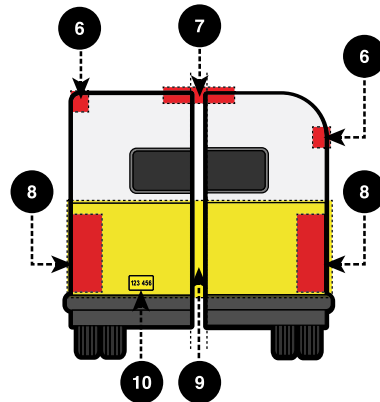
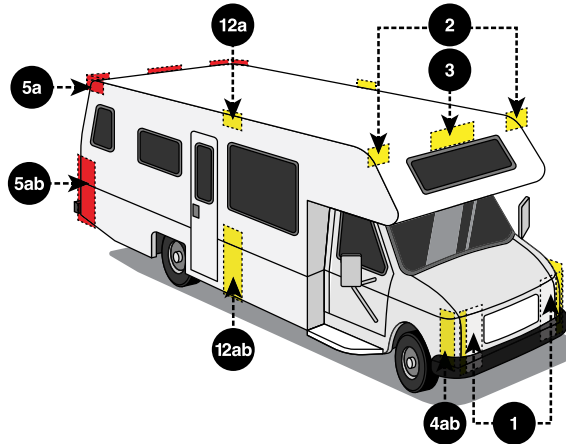
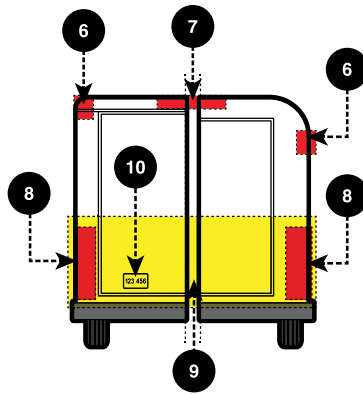
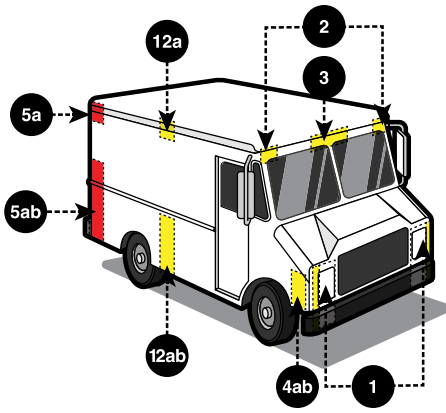

FEDERAL REGULATIONS

IMPORTANT NOTE: Every lamp, reflex reflector, and conspicuity treatment (device) must be permanently attached in the location specified below and must comply with all applicable requirements prescribed for it by FMVSS/CMVSS 108. The face of any device on the front/rear and sides should be, respectively perpendicular and parallel to vehicle centerline, unless it is photometrically certified at installation angle. No part of the vehicle shall prevent any device from meeting its prescribed requirements unless an auxiliary device meeting all prescribed requirements is installed.

In Canada: Manufacturers and importers of vehicles must have the proper certification test records demonstrating compliance of lighting components with all prescribed requirements.

BASIC EQUIPMENT REQUIRED ON ALL TRAILERS

DESCRIPTION				MANDATORY REQUIREMENTS			
Area	Equipment	(SAE Lens Coding)	Functional Purpose	QTY	Color	Location	Height mm (in.) from the ground
1	Tail Lamps	(T)	Indicate vehicle's presence and width	Minimum 2	Red	On the rear - symmetrical - as far apart as practicable	380-1830 (15-72)
	Stop Lamps	(S)	Indicate braking	Minimum 2	Red	On the rear - symmetrical - as far apart as practicable	380-1830 (15-72)
	Rear Turn Signal Lamps	(I)	Indicate direction of turn	Minimum 2	Red or Yellow	On the rear - symmetrical - as far apart as practicable	380-2110 (15-83)
	Rear Reflex Reflectors	(A)	Indicate vehicle's presence and width	Minimum 2	Red	On the rear - symmetrical - as far apart as practicable - facing rearward	380-1530 (15-60)
2	License Plate Lamp(s)	(L)	Illuminates license plate	Minimum 1	White	On the rear - above or at the sides of license plate	No requirement
3	Rear Side Marker Lamps	(P2, PC* or P3*,PC2) *photometrically certified at installation angle	Front and rear side marker lamps / side reflex reflectors indicate vehicle's presence and length	Minimum 2	Red	Each side at rear - as far back as practicable	380-1530 (15-60) no max. for veh. under 2.032m(80") wide
	Rear Side Reflex Reflectors	(A)		Minimum 2	Red	Each side at rear - as far back as practicable facing sideward	380-1530 (15-60)
4A	Front Side Marker Lamps	(P2, PC* or P3 ,PC2*) *photometrically certified at installation angle		Minimum 2	Yellow	Each side at front - as far forward as practicable	380 (15) minimum
4B	Front Side Reflex Reflectors	(A)		Minimum 2	Yellow	Each side at front - as far forward as practicable facing sideward	380-1530 (15-60)

ADDITIONAL EQUIPMENT FOR TRAILERS EXCEEDING THE FOLLOWING PARAMETERS

Length 9.1 m (30 ft.) or Longer

DESCRIPTION				MANDATORY REQUIREMENTS			
Area	Equipment	(SAE Lens Coding)	Functional Purpose	QTY	Color	Location	Height mm (in.) from the ground
5A	Intermediate Side Marker Lamps	(P2 or PC)	Indicate presence of a long vehicle	Minimum 2	Yellow	Each side near center - facing sideward	380 (15) minimum
5B	Intermediate Side Reflex Reflectors	(A)	Indicate presence of a long vehicle	Minimum 2	Yellow	Each side near center - facing sideward	380-1530 (15-60)

Width 2.032 m (80 in.) or Wider

DESCRIPTION				MANDATORY REQUIREMENTS			
Area	Equipment	(SAE Lens Coding)	Functional Purpose	QTY	Color	Location	Height mm (in.) from the ground
6	Rear Clearance Lamps	(P2, PC* or P3*,PC2) *photometrically certified at installation angle	Show vehicle's width - MAY NOT be combined with tail lamps	Minimum 2	Red	At widest point - symmetrical - on the rear or near the rear - facing rearward	As high as practicable - may be lower only if ID lamps are at the top
7	Rear Identification Lamps	(P2 or P3)	Indicate presence of a wide vehicle	Exactly 3	Red	On the rear-center, facing rearward - horizontally spaced 150 mm (6 in.) to 300 mm (12 in.) apart	in Canada : at the top - maybe lower if door header narrower than 25 mm in USA: as high as practicable
8	Front Clearance Lamps	(P2, PC* or P3*,PC2) *photometrically certified at installation angle	Show vehicle's width	Minimum 2	Yellow	At widest point - symmetrical - as far forward as practicable - facing forward	As high as practicable

Width 2.032 m (80 in.) or Wider and GVWR 4536 Kg (10,000 lb.) or More

DESCRIPTION		MANDATORY REQUIREMENTS					
Area	Conspicuity Treatment	DOT Coding	Quantity	Color	Location	Height	Options
9	Rear Upper Body Marking	DOT-C, DOT-C2, DOT-C3, or DOT-C4	Exactly 2 pairs of 300mm long strips	White	On the rear upper corners - facing rearward	At the top	Reflex reflectors may not be required if they are replaced, in their required location, with conspicuity treatment Optional in Canada Rear lower body and side conspicuity treatment may also be solid white, solid yellow, or white and yellow.
10	Bumper Bar Marking		Continuous	Red/White	On the rear bumper bar's horizontal element - full width - facing rearward	No requirement	
11	Rear Lower Body Marking		Continuous	Red/White (see options)	On the rear - full width of the vehicle - facing rearward	As horizontal as practicable and as close as practicable to the range of 375 to 1525 mm from the ground	
12	Side Marking		see location	Red/White (see options)	Each side - facing sideward - continuous, or evenly spaced over minimum of 50% of length, starts and ends as close to the front and rear or vehicle as practicable	As horizontal as practicable and as close as practicable to the range of 375 to 1525 mm from the ground	

TRAILER EQUIPMENT LOCATION REQUIREMENTS

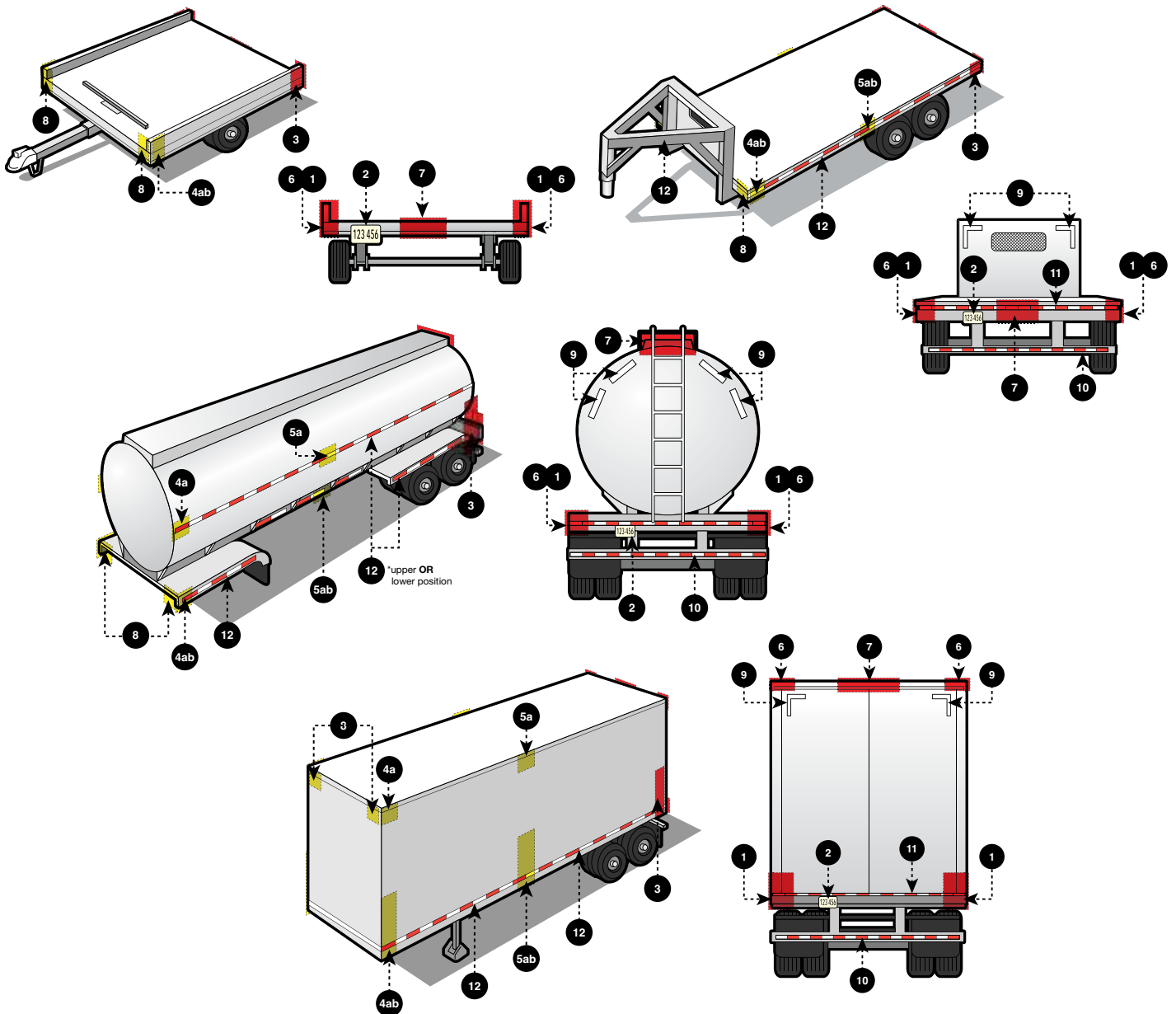

TRAILER EQUIPMENT LOCATION REQUIREMENTS

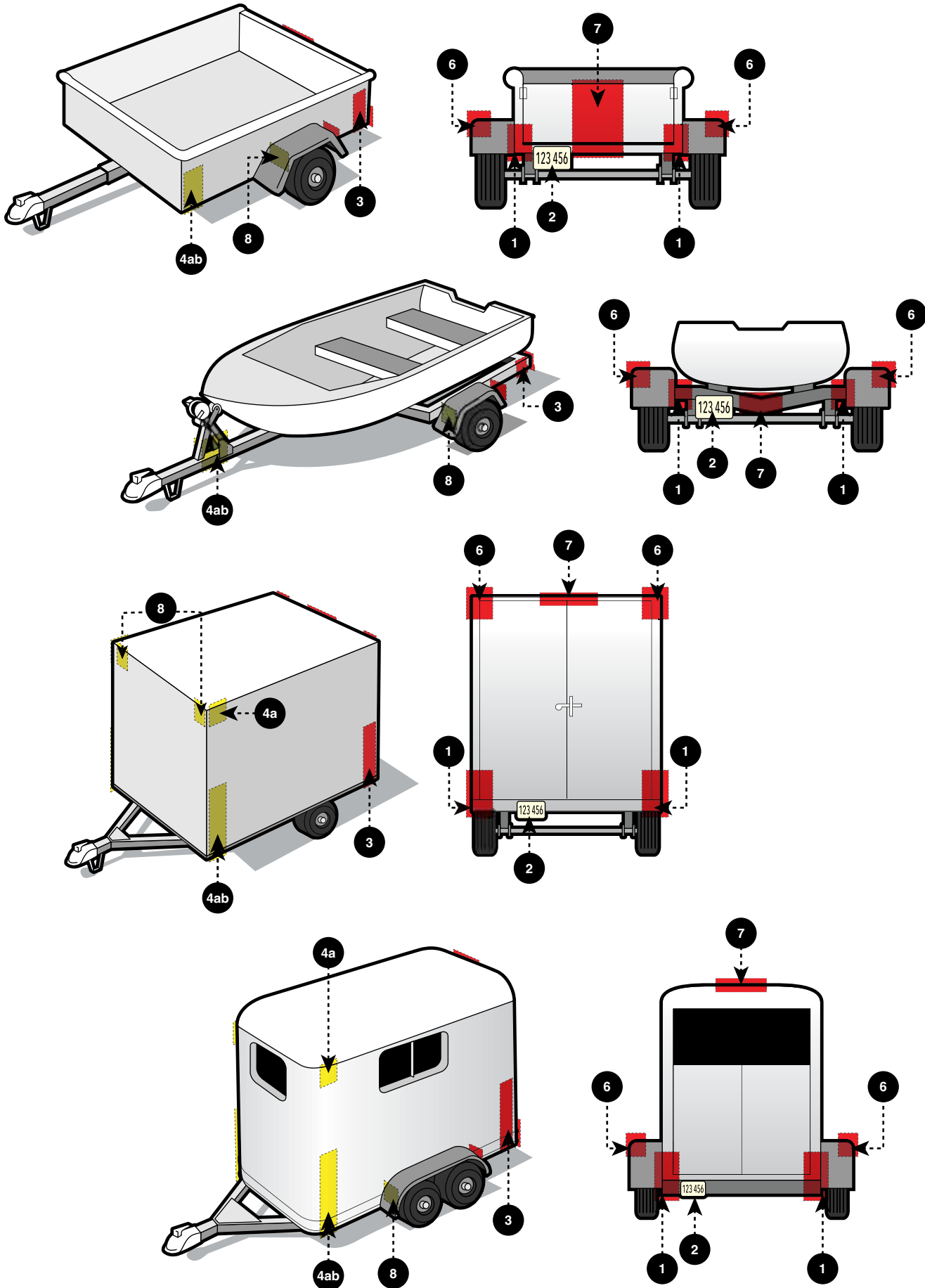

New Accounts

Initial buy-in amount and/or quantity is to be determined by United Pacific Industries, UPI hereafter. All initial orders must be prepaid in advance by Cashier's Check or VISA/MC/AMX. All new/potential accounts must complete a UPI "New Dealer Info/Credit Form" and follow the Dealer Qualification Instructions. Upon completion of the credit application, approved accounts will be assigned payment terms of NET 30 Days (from invoice date). Accounts denied a credit line will be required to prepay in advance by Cashier's Check, ACH or Bank wire or VISA/MC/AMX.

Payment Terms

Term Accounts: Accounts with NET 30 Days terms are required to submit payment within the 30 days from the date of invoice. Acceptable forms of payment include checks, ACH (Automated Clearing House), or wire transfer.

A service charge of 1.5% per month will be imposed on invoices not paid within the 30-day term. Delinquent accounts will be required to pay Cash-In-Advance (CIA). Checks will be accepted but orders will not be released until the check is cleared by the bank. Past due invoices will delay current orders. Please check with UPI on your account status when placing an order.

Credit Cards

Accounts denied credit terms may be given the option to pay by Visa, MasterCard or American Express. The credit card will be charged upon shipment. A 3% service fee will be added to the invoice. Credit card payments will not be accepted once an order has been shipped. UPI does not accept Discover card.

COD

There is no COD payment offered.

Returned Checks

A \$30.00 NSF (Non-Sufficient Fund) fee will be assessed on each incidence a check is returned to UPI.

Ordering Guidelines

Placing Orders

New orders and PO's may be placed by any of the following methods:

- Dealer Portal
- Fax: (888) 986-5988
- E-mail: sales@upauto.com
- Telephone: In order to minimize errors, dealers are encouraged to submit their orders by fax or mail. Telephone orders are generally not preferred as to minimize errors. Utilize one of the methods above for placing orders.

Changes to Orders

Once orders are released for picking changes are no longer possible. Dealers would have to submit a new PO for any additional items needed.

Canceling Orders

Cancellation of Stock orders must be submitted via fax or email within 24 hours of the order date. If the Stock order has already shipped it will be the dealer's responsibility to return the order at the dealer's own expense. A restocking fee may apply, please see "Return" policy for further detail. Drop Ship orders cannot be canceled due to the priority processing.

Backorders

Dealers have the option of having their backorders shipped or canceled. UPI will notify dealer as to availability of backorders and will be able to ship any backorder items dealer still needs as part of their next stock order. UPI reserves the right to cancel backorders that are 2 month or older from invoice date.

Minimum Order

A minimum order of \$50.00 is required. Orders below \$50.00 will be assessed a minimum order fee of \$10.00.

Packaging

A 10% service charge will be added to orders with special packaging or UPC barcoding requirements.

Lead Times

Standard lead time for all United Pacific Stock orders is 5 business days from the receipt of the purchase order. Larger Stock orders may require a lead time of up to 7 business days. Drop Ship orders generally ship in 2 business days or less. Transit time of 3-5 business days must be considered when placing orders. UPI cannot be responsible for delays in shipment after an order leaves our warehouse. UPI will work to resolve delays with freight forwarding firms, however, delays do arise from time to time due to weather and unforeseen circumstances beyond UPI's control. Express orders are exempt; please view Freight/Shipping Policy for further detail.

Order Confirmation

United Pacific will acknowledge receipt of orders by email or EDI within 1 business day of receiving the PO. If confirmation is not received, please contact UPI to ensure your order was received.

Prepaid Freight

Stock orders between \$.01 and \$1,999.99 (US Lower 48 States and Canada), \$.01 and \$3,299.99 (Alaska and Hawaii), [all price net US\$], will be shipped FOB Long Beach, California. Stock orders of \$2,000.00 (US Lower 48 States and Canada), \$3,300.00 (Alaska and Hawaii), [all price net US\$], or more will be shipped Freight Prepaid Ground to a single location only. Exclusions on prepaid: 1) Grille Guard (item# 80000) will always ship FOB Long Beach. 2) Express NDA and 2-day orders, Special Net Pricing orders, and Special Quote Pricing orders ship FOB Long Beach. All drop shipment orders will be assessed a 5% processing fee. Drop shipment processing fee will be automatically added to the invoice without notice. No freight allowance or prepaid freight will be permitted for any drop shipment. All drop ship orders, regardless of order size, are FOB Long Beach, CA. A minimum order of \$50.00 is required. Orders below \$50.00 will be assessed a minimum order fee of \$10.00. United Pacific reserves the right to select the carrier of our choice. Freight paid orders do not include extra services such as liftgate fee.

Will Call Orders

Will Call orders can be picked up in 1-3 days after placing the order. Dealers will receive their scheduled pick-up time in the order confirmation. Dealers should always call ahead to confirm when order will be ready. Sorry no same-day pick-up allowed. Will Call hours are 8:30AM - 4:00PM PST.

Shipping Policy

International Shipments

Shipments to locations outside the continental United States will be shipped to the dealer's shipping agent or broker within the continental United States in accordance with the US freight policy. International dealers will be responsible for the duties and taxes of their respective country.

Express Orders

All express orders, such as Next Day, Second Day, 3 Day Service & Will Call, must be emailed, faxed, or sent via EDI. Order confirmation will be sent to the dealer for final approval. If confirmation is not received, please contact UPI to ensure your order was received. Dealers are required to sign off on express orders and send confirmation back to UPI. Cut off for express order is 10:00AM PST (Pacific Standard Time). Express orders received after 10:00AM PST will ship the next business day. Please contact UPI to confirm projected shipping date or will call time. Due to the high cost of express shipments, dealer may request UPI to notify them of freight charges. If dealer does not request confirmation, UPI will ship the express order.

Drop Shipments

All drop shipment orders will be assessed a 5% handling fee and will be automatically added to the invoice without notice. All drop shipment orders must be emailed, faxed, or sent via EDI. No freight allowance or prepaid freight will be permitted for any drop shipment; thus, all drop ship orders regardless of order size, are FOB Long Beach, CA

Claims

General Policy

All claims (Shortage, Mis-Shipped, Damage, Overage, Dealer Error & Billing Error) must be submitted to UPI within 3 business days of the receipt of shipment. Claims submitted beyond 3 business days of the receipt of shipment will be voided by UPI.

On all shipments, the person who signs and receives the shipment is responsible for noting on the Bill of Lading, in writing, whether any boxes arrived damaged or shorted. Failure to do so will void all claim rights between all parties. UPI will have no recourse against the trucking company if dealer does not note any damages or shortages on the Bill of Lading.

The dealer's receiving department must count and sign for the exact number of boxes received. Failure to follow the above instructions will void all claim rights between all parties.

Shortages / Mis-Ships / Damages

While UPI strives to fill every order with 100% accuracy, on occasion an item may get shipped in error or get damaged during shipping. In the event this occurs, please follow the process below. Note: This type of claim must be reported to UPI within three (3) business days of receiving the order.

1. Contact the United Pacific office to initiate the claim. To make it easy for you we have two acceptable methods for requesting the claim:
 - Email: returns@upauto.com
 - Fax : 888-986-5988

Note: To ensure you receive a timely credit, we cannot accept claim requests by phone.

2. You will be required to provide the following information:
 - Your business name
 - Contact name and telephone number (in case we have questions)
 - Date the order was received
 - A copy of the Packing List / Invoice noting the item number and quantity that was shipped in error or damaged during shipping.
 - Special instructions you have for us.
3. UPI will send a return label so you can ship the items back.
4. Once we receive the miss-shipped/damaged item(s) a credit will be issued to your account on the next billing cycle.
 - Shortages will be credit to the Dealers' account, unless dealer would like the shortages replaced.

Overages

UPI strives to provide our dealers with the best dealer service and products, in turn we would greatly appreciate any help from dealer in notifying UPI of any shipping overages. Dealers will be offered the option of retaining the merchandise or returning the merchandise to UPI at UPI's expense. If the items are to be returned, an RMA number and return shipping label will be provided.

Dealer Errors

Any item or quantity ordered in error by the dealer may be returned by contacting UPI for a RMA number.

1. We have two acceptable methods for requesting the RMA:
 - Email: returns@upauto.com
 - Fax : 888-986-5988

Note: To ensure you receive a timely credit, we cannot accept claim requests by phone.

2. You will be required to provide the following information.
 - Your business name
 - Contact name and telephone number (in case we have questions)
 - A list of the items number and quantity ordered in error
 - Special instructions you have for us
3. UPI will review the request to ensure the products are within the return period.

4. Once we have validated the request, United Pacific will issue an RMA number to the dealer. In issuing the RMA approval, the following conditions will apply:
- Returned items are subject to a 20% re-stocking fee.
 - Return shipping costs are the responsibility of the dealer.
 - Items must not have any retail/price sticker on exterior package/box/card or they will be returned to the dealer at dealer's expense and no credit given.
 - Items must be in good condition with original packaging intact, unblemished and in re-sellable condition, or they will be returned to the dealer at dealer's expense and no credit given.
 - Allow up to 30 days for the credit to be issued from the time the returned items are received.

Billing Errors

Billing errors should be reported to UPI within 3 business days of invoice receipt. Dealers are asked to provide the invoice number, part number, and quantities in question. Once verified, UPI will issue a credit or an invoice for the difference in billing error.

Warranty

General Policy

UPI offers a NO HASSLE WARRANTY RETURN policy. Warranty claims can only be submitted through an authorized UPI Distributor. UPI warranty is not transferable and applies to the original installation and purchase only. UPI warranty varies by product and each item's warranty period is stated on UPI's product web page. In no event shall UPI be liable for incidental or consequential damages, nor shall UPI be liable for any claims or damages arising out of or connected with the UPI warranty which exceed the purchase price of the products.

There are no warranties, expressed or implied (including any warranty of merchantability or fitness) that extend beyond this warranty. The warranty does not apply to costs associated with the loss of use of the product, loss of time, inconvenience, commercial loss, incidental or consequential damages. The warranty does not apply to products which are damaged or made defective by faulty or incorrect installation. UPI reserves the right to alter the designs of products without assuming any obligation to modify previously manufactured products and will only replace warranted products with redesigned products.

Warranty does not apply to merchandise that has been drilled, cut, welded, modified in any way or installed contrary to normal installation and usage. In addition, UPI cannot be held liable for damages caused by road hazards, accidents, misuse, neglect, water intrusion, abuse or corrosive environments including acid washes and highway snow/ice chemicals which can cause discoloration and corrosion in aluminum, chrome, stainless steel and light products. UPI reserves the right to credit returned merchandise at the initial purchase price or at the current selling price, which price ever is lower.

Aluminum / Chrome / Stainless Steel Products

Aluminum, chrome, and stainless steel products carry either a limited 6 month warranty, or a limited 1 year warranty (from invoice date) against defects in material or workmanship. Check the product page on our website for specific warranty period.

All Grill Guards (Item # 80000): A) Stainless Steel Materials and factory workmanship of the product itself carry a Limited Lifetime warranty. B) The Stainless steel polish and finish has a 12 month warranty. C) This warranty is provided only to the original purchaser/consumer, and on the original installation. Warranty is not transferable. Product failure or breakage due to accident/wreck or improper installation is not covered.

All mounting kits (Item # 80001, 80002, 80003, 80004, 80005): A) Steel Materials and factory workmanship on the sub-assembly bracket are Lifetime warranty. B) The painted or zinc finish has a 12 month warranty. C) Any ancillary components and parts (e.g. washers, bolts, spacers, etc.) which are not part of the sub-assembly, carry a 12 month warranty. D) This Warranty is provided only to the original purchaser/consumer, and on the original installation. Warranty is not transferable. Product failure or breakage due to accident/wreck or improper installation is not covered.

Lighting Products**Incandescent Lighting:**

All incandescent lighting products carry a limited 12 month warranty (from invoice date) against defects in material or workmanship. The limited 12 month warranty does not apply to several applications, such as, buses, construction equipment, and off road vehicles.

LED Lighting:

All LED lighting products carry a specific Limited Warranty (from invoice date) against defects in material or workmanship.

LED with vehicle specific application is limited lifetime warranty to an original purchaser with receipt. Examples of lifetime warranty product:

CTL5720LED CTL5720LED for 1957 Chevy, FTL3201LED-L for 1932 Ford.

LED Marker, 2", 2-1/2", 4", 7", Oval & Square Lights - Varies from 2 years to 10 years to Limited Lifetime, depending on specific item. The housing, bezel or mounting base on any light made from Chrome/Stainless carries a 6 month limited warranty.

LED Cab Lights and Kits, Double/Single Stud Turn Signal and PB/ KW/FL/VL or non-make Turn Signals and any/all Strip Lights - Varies from 2 years to 10 years to Limited Lifetime, depending on specific item. The housing, bezel or mounting base on any light made from Chrome/Stainless carries a 6 month limited warranty.

LED Beacon, Driving, Headlights, Work & Warning Lights - Varies from 6 months to 3 years. The housing, bezel or mounting base on any light made from Chrome/Stainless carries a 6 month limited warranty.

All LED Accessory Lights (Honda, Stainless Steel Double/Single face Lights, Interior Lights, License Plate Lights, and any Accent Lights. The housing, bezel or mounting base on any light made from Chrome/Stainless carries a 6 month limited warranty.

For any product that contains any type of light or LED, whether it is a stand alone light or LED, or part of a larger assembled item (e.g.. Rear light panel), modifying electrical wiring, sockets, lighting pigtails and any electrical connection from the original configuration will void the warranty of both wiring, pigtail and the light or LED unit and cannot be warranted.

Returns

General Policy

All returns must be authorized by UPI. All return requests must be faxed or e-mailed (returns@upauto.com). A RMA number (Return Merchandise Authorization Number) will be provided. Returns not possessing a valid RMA number are subject to rejection and will be returned to sender at the dealer's expense.

RETURNS / CATALOGS / DISCLAIMER

All dealers are encouraged to use the Warranty RMA Claim Form and Dealer Portal Dashboard.

Defective Goods / Warranty Return

UPI offers our dealers a No Hassle Warranty Return. Please follow the instructions below for requesting a RMA for defective goods:

1. If any warranty issues occur, simply contact the UPI for RMA number. To make it easy for you we have three acceptable methods for requesting the RMA.

Dealer Portal Dashboard
Email: returns@upauto.com
Fax: 888-986-5988

Note: To ensure you receive a timely RMA credit, we cannot accept RMA requests by phone.

2. You will be required to provide the following information:

Your business name
Contact name and telephone number (in case we have questions)
A list of the defective item number and quantity with the nature/reason of the defect

Special instructions you have for us
The enclosed fax form may be used for your convenience to request an RMA

3. UPI will review the request to ensure the products are within the stated warranty period.

4. Once we have validated the warranty items, a RMA confirmation, listing the items and cost will be faxed to the dealer within 3 business days. UPI will process the credit to your account within 30 days.

Note: The majority of time there will be no need to return the warranty product to us. However, from time to time, UPI may require some warranty products to be shipped back so we may analyze the cause of the failure. All warranty products that are required to be shipped back will be freight prepaid by UPI.

Stock Return - USA Only

United Pacific Industries encourages all dealers to regularly monitor the sales volume and stock level of their inventory items. As sales trends may slow the movement of specific items, our hope is that those items are featured as "close-out specials" as to minimize stock returns. We also understand that the dealer, from time to time, may accumulate over-stock items and desire to return those. Therefore, we have adopted the following policy below.

NOTE:

Items must have been purchased by the United States dealer requesting the stock return.

Items must have been purchased within the preceding 12 months.

Items that have been discontinued will not be considered for return.

1. Contact the United Pacific for RMA number. We have 3 acceptable methods for requesting the RMA:

Dealer Portal Dashboard
Email: returns@upauto.com
Fax: 888-986-5988

Note: To ensure you receive a timely RMA credit, we cannot accept RMA requests by phone.

2. You will be required to provide the following information:

Your business name
Contact name and telephone number (in case we have questions)
A list of the defective item number and quantity with the nature/reason of the defect

Special instructions you have for us

3. Your claim will be reviewed within 5 business days and you will be contacted by your sales representative who will discuss solutions to liquidate these slow moving items.

4. In the event United Pacific and the dealer agree to a credit in lieu of returning the items, this credit will be issued within 10 business days.

5. In the event items are returned by the dealer, United Pacific will issue an RMA number to the dealer. Once the RMA is issued, the following conditions will apply:

Returned items are subject to a 20% re-stocking fee.

Return shipping costs are the responsibility of the dealer.

Items must not have any retail/price sticker on exterior package/box/card or they will be returned to the dealer at dealer's expense and no credit given.

Items must be in good condition with original packaging intact, unblemished and in re-sellable condition, or they will be returned to the dealer at dealer's expense and no credit given.

Allow up to 30 days for the credit to be issued from the time the returned items are received.

6. Stock returns may be requested throughout the year and are subject to final approval by United Pacific.

All dealers are encouraged to use the Warranty RMA Claim Form and Dealer Portal Dashboard.

Closeout / Discontinue

UPI will not warranty or accept returns on Closeout/Discontinue items.

Procedure:

An inventory of the merchandise being returned must accompany each return. The RMA number should be prominently displayed on each carton/box.

All Returns must be returned freight prepaid.

Ship Returns to:

United Pacific Industries
Attn: Returns Department
3788 E. Conant St.
Long Beach, CA 90808

RMA:

Outstanding RMA's will be automatically cancelled if not used within 30 days of issuance.

Disclaimer

United Pacific Industries reserves the right to amend or update our Policies & Procedures without notice.

United Pacific Industries is not responsible for typographical, product information or print errors. Specifications on this catalog may be changed without advance notice. Products may look different from those in the photos on this catalog due to printing quality.

The image shows a 'DEFECTIVE GOODS / WARRANTY CLAIM FORM' from United Pacific. It includes a header with the United Pacific logo and contact information. Below the header is a section for 'DEFECTIVE GOODS / WARRANTY CLAIM FORM' with fields for Date, Company Name, Address, City, State, Zip, Contact Name, Phone Number, Fax Number, and Email. A table with columns 'Item #', 'Qty', 'Description', 'Reason for Defect', and 'RMA Number' is provided for listing items. At the bottom, there is a section for 'United Pacific Only' with fields for Date Received, Date Returned, RMA Number, Date Issued, and Approved By.

California Proposition 65 Warning as required by the State of California:



WARNING: This product can expose you to chemicals including acrylonitrile butadiene styrene, bisphenol and lead, chromium (hexavalent compounds), titanium dioxide, carbon black, diisononyl phthalate (dinp), which is known to the state of California to cause cancer or birth defects or other reproductive harm. Cancer and Reproductive Harm www.P65warnings.ca.gov

<u>ITEM #</u>	<u>PAGE #</u>	<u>ITEM #</u>	<u>PAGE #</u>	<u>ITEM #</u>	<u>PAGE #</u>	<u>ITEM #</u>	<u>PAGE #</u>
20397	85	31134	74	34242	92	36575	15
20401	85	31135	74	34243	91	36576	15
20404	85	31136	74	34244	91	36577	15
20407	85	31165	73	34249	88	36578	15
20422	85	31251	76	34255	89	36579	15
20425	85	31321	73	34270	89	36580	15
20428	85	31361	72	34271	90	36581	15
20436	84	31362	72	35995	7	36582	15
20451	84	31364	72	35996	7	36583	15
20549	81	31401	78	35997	7	36600	68
20708	84	31402	79	35998	7	36601	68
20725	84	31427	79	36008	71	36602	68
29072	81	31503	82	36012	71	36603	68
30005	70	31504	82	36014	71	36607	26
30008	70	31505	82	36022	23	36608	26
30020	71	31506	82	36035	11	36609	36
30051	70	31507	82	36036	11	36610	36
30055	70	31508	82	36037	11	36617	61
30141	71	31510	83	36379	73	36618	62
30143	77	31515	82	36409	72	36651	67
30145	71	31516	83	36410	76	36652	26
30168	69	33002	84	36451	79	36653	26
30361	78	33006	84	36454	59	36654	26
30362	77	33130	75	36455	59	36655	26
30703	80	33133	75	36456	59	36656	33
30704	80	33135	75	36457	59	36657	33
30709	80	33137	78	36461	59	36664	33
30710	80	33138	78	36462	59	36665	33
30711	80	33139	78	36463	59	36669	57
30712	80	34001	84	36464	59	36670	57
30713	80	34003	85	36506	60	36671	62
30714	80	34004	84	36507	60	36672	65
30723	80	34007	85	36515	60	36679	46
30724	80	34014	85	36516	60	36690	50
30726	80	34118	92	36524	16	36691	50
30918	20	34119	92	36525	16	36694	50
30919	84	34120	92	36526	16	36701	20
31039	77	34191	91	36527	16	36746	58
31050	70	34192	91	36533	61	36763	67
31059	69	34193	91	36534	61	36781	67
31061	69	34194	91	36535	61	36782	67
31065	69	34195	91	36536	61	36784	67
31076	75	34196	91	36560	16	36815	8
31077	75	34197	91	36561	16	36816	8
31079	76	34210	89	36562	16	36817	8
31080	76	34211	89	36563	16	36818	8
31101	70	34212	90	36568	45	36819	21
31106	76	34215	89	36569	32	36820	21
31109	70	34216	90	36570	32	36832	29
31126	72	34224	86	36571	32	36854	66
31131	74	34236	90	36572	32	36855	36
31132	74	34238	90	36573	46	36857	36
31133	74	34241	92	36574	15	36861	55

PRODUCT INDEX

<u>ITEM #</u>	<u>PAGE #</u>	<u>ITEM #</u>	<u>PAGE #</u>	<u>ITEM #</u>	<u>PAGE #</u>	<u>ITEM #</u>	<u>PAGE #</u>
36862	55	37008	45	38171	18	90505	93
36863	55	37009	46	38660	45	90506	93
36864	55	37016	17	38922	39	90507	93
36869	11	37017	17	39117	31	90600	94
36870	11	37018	17	39118	31	90601	94
36893	21	37019	17	39119	31	90602	94
36894	21	37033	31	39120	31	90620	95
36895	21	37034	31	39161	51	90621	95
36896	21	37035	17	39162	51	90622	95
36897	12	37036	17	39163	51	90623	95
36898	12	37074	63	39164	51	90624	95
36899	54	37077	44	39165	51	10500B	81
36901	54	37078	44	39207	27	10518B	81
36905	12	37079	55	39214	14	20487B	81
36906	12	37080	55	39214	25	20549B	81
36907	12	37081	55	39215	14	30001B	83
36908	12	37082	55	39215	25	30002B	83
36909	43	37083	40	39218	32	30051AK-B	70
36910	43	37084	40	39219	32	30051AK-C	23
36912	43	37087	63	39222	14	30051AK-C	70
36913	30	37088	66	39223	14	30055RK-B	70
36914	30	37089	56	39254	7	30055RK-C	23
36915	30	37090	56	39256	7	30055RK-C	70
36921	53	37091	56	39298	9	30141AK-C	71
36922	28	37092	56	39299	9	30145RK-B	23
36923	28	37123	64	39300	9	30145RK-B	71
36924	34	37124	40	39301	9	30145RK-C	23
36925	34	37125	40	39302	9	30145RK-C	71
36944	52	37128	37	39303	9	31050ARK-B	70
36954	37	37129	37	39304	9	31055AK	69
36955	37	37130	33	39305	9	31059RK	69
36956	37	37131	33	39311	9	31061AK	69
36957	30	37132	25	39312	9	31065RK	69
36958	30	37133	25	39343	29	31101AK	70
36965	62	37134	25	39688	63	31106CK	76
36968	11	37135	25	39773	57	31109RK	70
36969	11	37142	12	39774	57	31251CK	76
36970	11	37143	12	39775	57	31362RK	72
36971	11	37144	12	39776	57	33003B	84
36976	24	37157	66	39821	27	33136B	77
36977	24	37190	57	39821	29	33539B	35
36980	8	37233	53	39901	65	34213B	86
36981	8	37235	53	39909	48	34214B	86
36984	10	37236	53	39979	64	34224P	86
36985	10	37237	53	40086	44	34242-2	86
36986	10	37510	56	40089	44	34242-3	86
36988	10	37511	56	40108	95	34242-4	87
36989	10	37512	56	60054	81	34242-5	87
36990	10	37513	56	90500	93	34242-6	87
36992	24	37563	64	90501	93	34242-7	88
36993	24	37597	65	90502	94	34242-8	88
36995	24	37627	54	90503	94	36409AK	72
37000	52	38005	56	90504	93	36410CK	76

<u>ITEM #</u>	<u>PAGE #</u>	<u>ITEM #</u>	<u>PAGE #</u>	<u>ITEM #</u>	<u>PAGE #</u>	<u>ITEM #</u>	<u>PAGE #</u>
36499B	58	36992B	24	38143B	44	38828B	47
36515B	60	36993B	24	38143BAK	44	38828BCK	47
36630B	50	37008B	45	38158B	24	38849B	19
36652B	26	37008BCK	45	38159B	24	38849BAK	19
36654B	26	37009B	46	38161B	24	38850B	19
36679B	46	37009BCK	46	38161BAK-B	24	38850BRK	19
36679BCK	46	37016B	17	38162B	24	38900B	39
36680B	46	37016BAK	17	38162BAK-B	24	38901B	39
36680BCK	46	37017B	17	38168B	20	38920B	39
36683B	50	37017BRK	17	38169B	20	38920BAK	39
36684B	50	37035B	17	38170BAK	18	38922B	39
36743B	13	37035BAK	17	38170CB	18	39117B	28
36744B	13	37036B	17	38171B	18	39117BRK	28
36745B	13	37036BAK	17	38171BRK	18	39118B	31
36771B	35	37042B	51	38171CB	18	39119B	28
36771B	38	37045B	51	38176B	20	39119BAK	28
36771BRK	35	37088B	66	38176BAK	20	39311B	9
36771BRK	38	37089B	58	38177B	20	39312B	9
36773B	68	37090B	58	38177BRK	20	39313B	9
36773BCK	68	37091B	56	38259B	22	39341BAK	38
36774B	22	37092B	56	38309BK	43	39353B	41
36774BARK-B	22	37128BRK	34	38310B	42	39354B	41
36832B	29	37129BAK	34	38311B	42	39398B	8
36832BRK	29	37132B	25	38362CB	18	39399B	8
36849B	13	37132BRK	25	38363CB	18	39552B	42
36850B	13	37133BAK	25	38395B	48	39654BRK	33
36855B	38	37158B	52	38455B	19	39656B	27
36855BRK	38	37159B	52	38455BAK	19	39688B	63
36861B	55	37160B	52	38456B	19	39739BAK	19
36862B	55	37163B	52	38456BRK	19	39740BRK	19
36863B	55	37164B	52	38457B	19	39767B	13
36864B	55	37182B	53	38457BAK	19	39768B	13
36922B	28	37184B	53	38458B	19	39901B	65
36922BRK	28	37186B	51	38458BRK	19	39904B	22
36923B	28	37187B	51	38463B	58	39905B	22
36923BAK	28	37189B	51	38465B	20	39924B	29
36924B	34	37192B	57	38465BAK	20	39924BRK	29
36924BRK	34	37537B	54	38466B	20	39930B	49
36925B	34	37538B	54	38469B	58	39931B	47
36925BAK	34	37541B	54	38473B	43	39960B	31
36926B	53	37542B	54	38474B	43	39961B	31
36961B	39	37544B	54	38490B	41	39973BAK	29
36961BAK	39	37625B	68	38491B	41	39984B	18
36962B	39	37626B	68	38746B	42	39984BAK	18
36962BRK	39	38005B	56	38746BAK	42	39985B	18
36977B	24	38030B	49	38747BRK	42	39985BRK	18
36977B	24	38031B	47	38770B	27	39990B	58
36980B	8	38061B	30	38770BRK	27	39994B	49
36981B	8	38112BRK	28	38771B	27	39995B	49
36984B	10	38116B	27	38771BAK	27	39998B	48
36985B	10	38116BRK	27	38775BAK	38	39998BCK	48
36988B	10	38121B	35	38778B	48		
36989B	10	38121BRK	35	38778BCK	48		



United Pacific

UPauto.com | T 800.790.6988 | F 888.986.5988

© 2023 United Pacific Industries. All rights reserved.
Products not shown to scale. Specifications subject to change without notice.

UCOEM3

OEM LIGHTING CATALOG 3RD EDITION



710270065431